

SM/SMBW™ 4000 Series Filter Operating Manual

IMPORTANT SAFETY INSTRUCTIONS
READ AND FOLLOW ALL INSTRUCTIONS
SAVE THESE INSTRUCTIONS

Table of Contents

SECTION I.	FILTER OPERATION.....	1
SECTION II.	FILTER INSTALLATION.....	3
SECTION III	TROUBLE SHOOTING	6
SECTION IV.	TECHNICAL DATA	7
A.	REPLACEMENT PARTS	7
	WARRANTY	8

WARNING

Before installing this product, read and follow all warning notices and instructions accompanying this filter. Failure to follow safety warnings and instructions can result in severe injury, death, or property damage. Call (800) 831-7133 for additional free copies of these instructions.

Important Notice



Attention Installer.

This manual contains important information about the installation, operation and safe use of this product. This information should be given to the owner/operator of this equipment.

SECTION I. FILTER OPERATION.

A. GENERAL INFORMATION.

1. This filter operates under pressure. When closed properly and operated without air in the water system, this filter will operate in a safe manner.
2. Warning labels should be affixed to the top of the filter and on the clamp bands at all times. Keep safety labels in good condition. Replace missing or damaged safety labels.
{For free labels call (805) 523-2400 or (919) 774-4151.}

Pentair Pool Products

1620 Hawkins Ave., Sanford, NC 27330 • (919) 774-4151
10951 West Los Angeles Ave., Moorpark, CA 93021 • (805) 523-2400



Because **reliability** matters most

3. The "SM/SMBW" Series Filter has been listed and approved by the National Sanitation foundation. This booklet will enable you to install and operate your pool filter in the correct manner. Correct installation and operation will result in the trouble free operation of a quality product, as well as prevent unnecessary repairs.

4. **Model SMBW Filter System**

a. Standard SM Series Filter with built-in backwash valve. Simplifies plumbing installations.

5. **Model SM Filter System**

a. Standard SM Series requires separate valves for backwash.

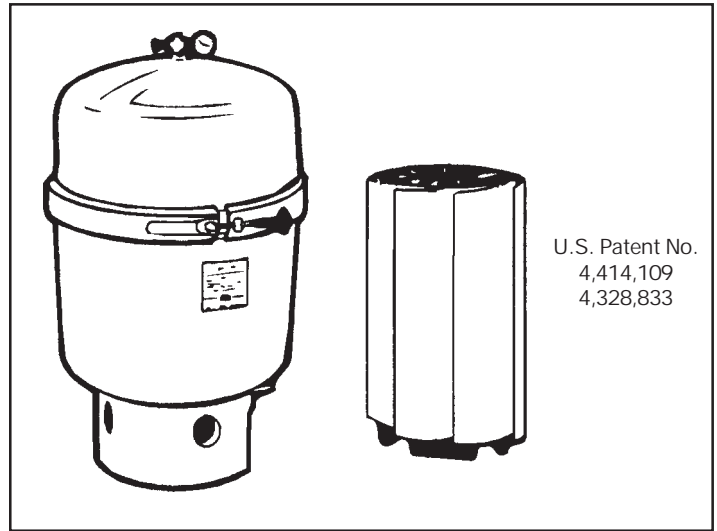

CAUTION

Before starting any filter system, be sure the pump has been adequately primed by filling the strainer on the pump with water. Failure to do so will result in pump seal problems. When installing in conjunction with a heater, a one-way check valve should be used between the filter and heater to prevent the backflow of hot water from damaging the filter internals.

B. WHAT IS DIATOMACEOUS EARTH AND HOW DOES IT FILTER WATER?

1. Diatomaceous earth is the skeletal remains of microscopic one-cell aquatic plants called diatoms, also known as diatomite, D.E., and more properly diatomaceous earth.
2. Under the microscope, these minute diatoms show an amazingly intricate design and variety of forms, such as disc-shaped, boat-shaped, needle-like and many have a lace-like porous structure.
3. When used as a filter aid, the diatomaceous earth is mixed with water to form a slurry for filter 'precoat'. This mixture is introduced into the filter system by means of a slurry pot, or by pouring directly into the surface skimmer with the pump running. The minute diatoms are deposited on the outer surface of the filter elements, forming a 'strawpile' layer or cake by interlacing and overlapping, and thus providing countless microscopic channels which entrap suspended impurities, but allow clear water to pass through without clogging.
4. We recommend the use of D.E. which is sold and labeled for use with swimming pools and spas. These grades of D.E. typically have a median particle size of 34 microns, which is ideal for most applications.

WARNING

Failure to operate your filter system or inadequate filtration can cause poor water clarity obstruction visibility in your pool and can allow diving in shallow pool area, or diving into or on top of obscured objects which can cause serious bodily injury or drowning.

C. FILTER PRECOATING INSTRUCTION:

1. Mix the Diatomaceous Earth in a pail of water to form a slurry, then pour the mixture directly into the surface skimmer with the pump running. Insure that the right quantity of D.E. is used as shown in the table.

Diatomaceous Earth (D.E.) Precoat Requirements	
Filter Model Number	*By Weight Pounds
4024	2.4
4036	3.6
4048	4.8
4060	6.0

* By Weight - 1 lb. of D.E. per 10 sq. ft. of filter surface area.

SECTION II. FILTER INSTALLATION.

A. GENERAL INFORMATION

WARNING



THIS FILTER OPERATES UNDER HIGH PRESSURE. WHEN ANY PART OF THE CIRCULATING SYSTEM, e.g., CLAMP, PUMP, FILTER, VALVE(S), ETC. IS SERVICED, AIR CAN ENTER THE SYSTEM AND BECOME PRESSURIZED. PRESSURIZED AIR CAN CAUSE THE LID TO BE BLOWN OFF WHICH CAN RESULT IN SEVERE INJURY, DEATH, OR PROPERTY DAMAGE. TO AVOID THIS POTENTIAL HAZARD, FOLLOW THESE INSTRUCTIONS.

1. BEFORE REPOSITIONING VALVE(S) AND BEFORE BEGINNING THE ASSEMBLY, DISASSEMBLY, OR ADJUSTMENT OF THE CLAMP OR ANY OTHER SERVICE OF THE CIRCULATING SYSTEM: (A) TURN THE PUMP OFF AND SHUT OFF ANY AUTOMATIC CONTROLS TO ENSURE THE SYSTEM IS NOT INADVERTENTLY STARTED DURING THE SERVICING; (B) OPEN THE AIR RELIEF VALVE; (C) WAIT UNTIL ALL PRESSURE IS RELIEVED.
2. WHENEVER INSTALLING THE FILTER CLAMP FOLLOW THE FILTER CLAMP INSTALLATION INSTRUCTIONS EXACTLY.
3. ONCE SERVICE ON THE CIRCULATING SYSTEM IS COMPLETE FOLLOW SYSTEM RESTART INSTRUCTIONS EXACTLY.
4. MAINTAIN CIRCULATION SYSTEM PROPERLY. REPLACE WORN OR DAMAGED PARTS IMMEDIATELY, e.g., clamp, pressure gauge, valve(s), O-rings, etc.
5. BE SURE THAT THE FILTER IS PROPERLY MOUNTED AND POSITIONED ACCORDING TO INSTRUCTIONS PROVIDED.

1. New pools have a tremendous amount of debris due to dirt in the lines, plaster dust, etc. This debris will be removed by the filter and will require daily backwashing of the filter until it is removed. Check the pressure gauge daily and backwash the filter when the pressure increases 8 - 10 psi over the initial reading. It will require several backwashings before the pool is clean. Thereafter, the normal filter cycle will be several weeks in a properly designed system. The filter cycle is lengthened or shortened by contamination loads.
2. When installing backwash lines, it is recommended to install a vacuum breaker where the backwash line is over 40 feet long, or if the line discharges 10 feet or more lower than the water level of the pool. Operating at excessive vacuum levels can cause the tank to implode, which voids the warranty.
3. A check valve is recommended between the filter and heater to prevent hot water backup from damaging the filter internals.
4. The maximum operating pressure of the tank is 50 psi. Never operate the unit above this pressure or attach a pump to this filter that has a shut off pressure higher than 50 psi.
5. Never install a chemical feeder or ozonator upstream of the filter. Always locate downstream with a check valve between the feeder and the filter.
6. A positive shut off valve is not recommended downstream of the filter and/or heater. If the system is ever run with such a valve closed, the internal air vent becomes inoperative and an explosive situation could exist. Running the system with no flow can seriously damage the equipment.
7. Clean your filter when pressure reads between 8-10 psi higher than the original starting pressure. Your filter pressure reading will increase as it removes dirt from your pool. However, this buildup of pressure will vary due to different bathing loads, temperature, weather conditions, etc.
 - a. MY ORIGINAL STARTING PRESSURE IS _____ psi (pounds per square inch). I SHOULD BACKWASH (CLEAN) THE FILTER AT _____ psi.
8. Check carton for any evidence of damage due to rough handling in shipment. If carton or any filter components are damaged, notify freight carrier immediately.
9. The filter should be mounted on a level concrete slab. Position the filter so that instructions, warnings and the pressure gauge are visible to the operator. It also should be positioned so that the piping connections, control valve and drain port are convenient and accessible for servicing and winterizing.

10. Provide space and lighting for routine maintenance access. Do not mount electrical controls over filter. Install electrical controls (e.g., on/off switches, timers, control systems, etc.) at least five (5) feet from the filter. This will allow you enough room to stand clear of the filter during system start up.
11. Allow sufficient clearance around the filter to permit visual verification that the clamp is properly installed around the tank flanges, see Figure 1.
12. Allow sufficient space above the filter to remove the filter lid for cleaning and servicing. This distance will vary with the model of filter you are using. See Table 1. for the required vertical clearance.

Model	Size	Vertical Clearance Req.	NSF
011553	23 sq. ft.	33 in.	yes
011554	35 sq. ft.	39 in.	yes
011555	47 sq. ft.	45 in.	yes
147411	58 sq. ft.	51 in.	yes

B. TO OPERATE FILTER

⚠ WARNING	
	THIS FILTER OPERATES UNDER HIGH PRESSURE. WHEN ANY PART OF THE CIRCULATING SYSTEM, e.g., CLAMP, PUMP, FILTER, VALVE(S), ETC. IS SERVICED, AIR CAN ENTER THE SYSTEM AND BECOME PRESSURIZED. PRESSURIZED AIR CAN CAUSE THE LID TO BE BLOWN OFF WHICH CAN RESULT IN SEVERE INJURY, DEATH, OR PROPERTY DAMAGE. TO AVOID THIS POTENTIAL HAZARD, FOLLOW THESE INSTRUCTIONS.

1. Set rotary valve handle in the filter position.
2. Open air relief valve on top of filter. **STAND CLEAR OF THE FILTER.**
3. Start pump and wait until a steady jet of water emerges from air relief valve, then close valve.
4. Introduce the required amount of Diatomaceous Earth into filter, see page 2.
5. Filter will operate efficiently until pressure gauge indicates time for backwashing.

C. TO BACKWASH (CLEAN) FILTER

⚠ WARNING
To prevent equipment damage and possible bodily injury and/or property damage, always turn the pump off before changing the valve positions.

1. Pressure backwashing is accomplished in three easy steps:
 - a. Turn pump off.
 - b. Rotate handle of rotary valve 90° as shown in Figure 2. **STAND CLEAR OF THE FILTER.**
 - c. Turn pump on.
 - d. Backwash for approximately two minutes or until effluent appears clean. When backwashing is complete, turn pump off, rotate handle back to filter position and you are ready for filter operation again. Precoat filter with D.E. as shown on page 2.

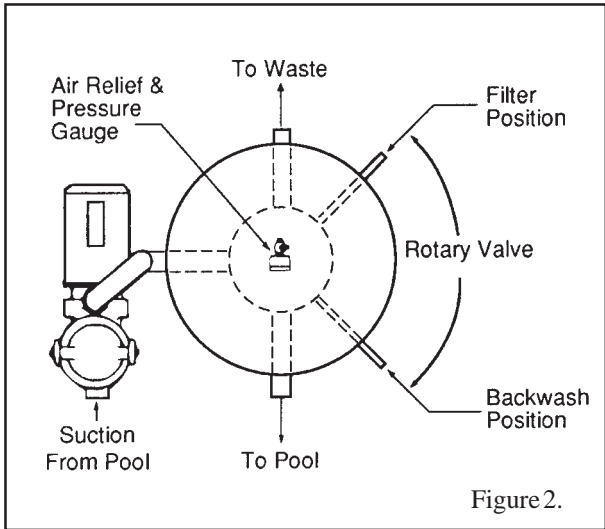
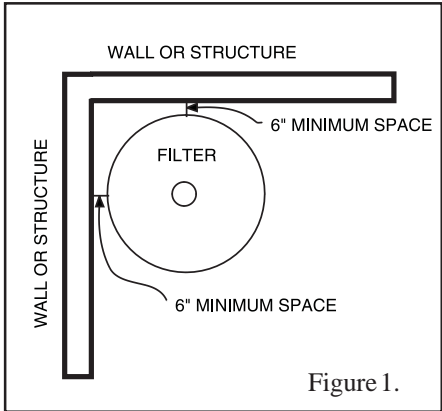

D. HOW TO CLEAN THE SEPARATION TANK, performed after each backwash operation. *(If installed or if applicable.)*

The purpose of the separation tank is to collect the spent diatomaceous earth during backwashing (cleaning) of the filter. It must be cleaned after each backwash to prevent any clogging problems. It is recommended that this procedure be repeated to ensure complete backwashing of the filter. One backwashing may not be sufficient.

1. Open valve C and valve D* to drain separation tank. While the tank drains, the filter can be pre-coated and restored to the filter cycle. Be sure valve B is closed; see Figure 3.

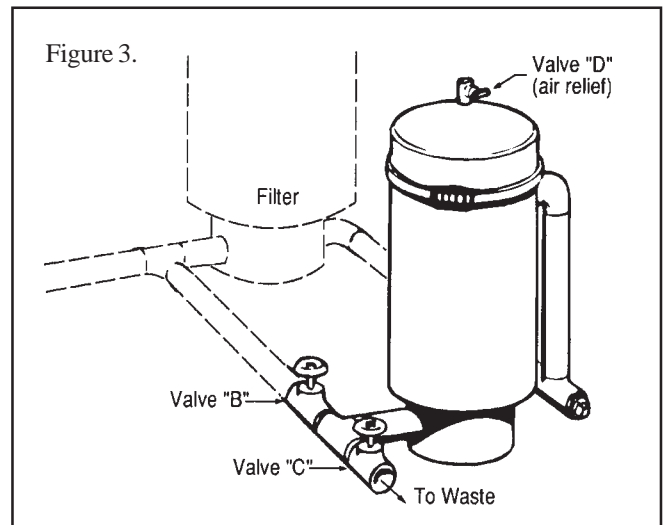

WARNING

Valve "D" is the air relief valve. It is important that this valve be opened before proceeding further. The tank is pressurized and is dangerous if the air is not vented prior to removing the lid clamp. Failure to open the air relief valve could cause the lid to separate resulting in serious bodily injury and/or property damage.

2. To remove the clamping ring, partially unscrew the adjustment knob and release the head of the T-bolt from the slotted bracket.
3. Remove tank lid with screwdriver or with a tool available from the manufacturer. Avoid cutting rubber O-ring.
4. When water has drained from bag, remove bag from tank by grasping the handles of the bag with both hands; pushing down with one hand; pulling up with the other and lifting bag out.
5. Turn bag inside out and empty contents in a waste container. Rinse bag with garden hose.
6. Install bag in tank with the rim of the bag immediately below the tank inlet opening, then push down on the rim opposite the inlet opening until the rim is level.
7. Remove rubber O-ring and clean both O-ring and channel. Lubricate O-ring with a non-water soluble grease or silicone lubricant and replace O-ring in channel.
8. Clean the inside surface of the tank lid where it seals against the O-ring. Place lid on tank; push down on lid to seat in-place.
9. Replace the clamping ring. Engage the head of the T-bolt into the slotted bracket and tighten the adjustment knob. Hand tighten only.

E. HOW TO CLEAN FILTER MANUALLY & WINTERIZING INSTRUCTIONS

(Required at least once a year and when winterizing your filter to prevent damage during freezing conditions.)

1. Turn pump off.
2. Set valve handle or valves for backwash position, (for SMBW only).
3. **STAND CLEAR OF THE FILTER** - Turn pump on and run for 3 minutes, then turn pump off.
4. Drain filter with respect to opening the air relief valves as discussed in a, b, and c, below.
 - a. To drain filter Model SM with gate valves, open drain valve and tank air relief valve and close all other valves.

WARNING

Valve "D" is the air relief valve. It is important that this valve be opened before proceeding further. The tank is pressurized and is dangerous if the air is not vented prior to removing the lid clamp. Failure to open the air relief valve could cause the lid to separate resulting in serious bodily injury and/or property damage.

- b. To drain filter model SMBW, set valve handle to backwash position and open tank air relief valve.
 - c. To drain filter model SMBW with Separation Tank, set valve handle to backwash position; open tank air relief valve; close all other valves and remove drain plug on backwash line.
5. To remove the clamping ring, unscrew the adjustment knob and open clamp band.
 6. Remove tank lid with screwdriver or with a tool available from the manufacturer. Avoid cutting rubber O-ring or bending of lid or tank O-ring channel.

7. Use garden hose to rinse down filter elements until all debris has been flushed from tank. Then screw drain plug on backwash line on models with Separation Tank.
8. Unscrew wing nut; remove washer and unclip air vent tube from holding wheel. Remove holding wheel.
9. Lift out filter elements and scrub each element with a soft brush. If elements are coated with scale, it will be necessary to brush with a mild solution of muriatic acid (10 parts water to 1 part muriatic acid). Rinse elements with water.
10. Remove manifold and inspect for damage. Replace rotor O-ring & lubricate as needed.
11. Replace clean elements in manifold sockets; notch on element will guide it to proper position. All elements are interchangeable.
12. Replace holding wheel over center rod; place washer over rod and turn holding wheel until elements spread to widest gap. Replace washer, then screw wing nut on rod. **Do not tighten nut beyond finger tight.** Be sure to clip air vent tube back into slot on holding wheel. Clean vent tube screen cap of any debris.
13. Remove rubber O-ring and clean both O-ring and channel. Lubricate O-ring with a non-water soluble grease or silicone lubricant and replace O-ring in channel.
14. Clean the inside surface of the tank lid where it seals against the O-ring. Place lid on tank; push down on lid to seat in place.
15. Replace the clamping ring. Engage the bolt through the bolt clamp and tighten the adjustment knob. (Hand tighten only.)
16. To restore to the filter cycle, refer to the operating and cleaning instructions of the filter model involved. When winterizing, ensure that all water is removed from the lower internal portion of the filter.

SECTION III. TROUBLE SHOOTING

A. Before performing any of the recommended actions below, it is important to consult the instruction manual including all warnings.

SYMPTOMS	WHAT TO LOOK FOR	RECOMMENDED ACTION
Earth (D.E.) To Pool NOTE: Be sure the foreign material in the pool is diatomaceous earth.	Internal parts not assembled correctly.	Check assembly of internal parts making sure they are correctly in place.
	Damaged manifold.	Replace manifold.
	Torn element fabric.	Repair fabric or replace element.
	Diatomaceous earth back up at main drain.	Check for air leaks, repair as necessary. Air leaks can cause system to drain down allowing D.E. back to the pool.
	Missing vent cap.	Replace cap.
Leak At Lid	Damaged o-ring.	Replace o-ring.
	Contaminated o-ring.	Clean o-ring; clean inner lip of lid and retainer band at top of tank.
	Clamping band too loose.	Tighten clamping band.
	Crack in lid or tank body.	Replace cracked part.
High Pressure Reading On Filter Gauge	Restriction on discharge side.	Locate and correct restriction of filter.
	Calcium deposits on filter elements.	Remove and acid wash elements.
	Excessive water flow through filter (pump horsepower may exceed filter flow rate).	Establish pump flow rate and compare with max. filter flow rate requirement.
	If heater is included in system, flow valve on heater may be stuck open.	Adjust or replace flow valve as necessary.
	Filter gauge not working properly.	Inspect and repair gauge; replace if necessary.
Short Filter Cycle	Poor backwash procedure.	Use correct backwash procedure.
	Too little or too much D.E.	Backwash and add correct amount of D.E.
	Algae in water.	Correct and maintain proper water chemistry. Frequent backwashing may be necessary until pool is free of algae.

SECTION IV. TECHNICAL DATA

A. REPLACEMENT PARTS

1. Model SM/SMBW 4000 Filter

Item#	Description	P/N	Qty
1	Complete gauge assy. includes: Gauge 1/4" 60 lbs Tee 1/4 brass Valve air release 1/4" Nipple plastic 1/4"	073027 155050 071982 075207 071390	1
1	Manual air relief 4060	273550	1
	Nut 2" (4060 only)	154412	1
2	Lid SM/SMBW 4024 replmt. Lid SM/SMBW 4036 replmt. Lid SM/SMBW 4048 replmt. Lid SM/SMBW 4060 replmt.	197134 197135 197136 197137	1
3	Clamp ring assy.	197020	1
4	Holding wheel 4024, 4036, 4048 Holding wheel 4060	071019 197120	1 1
5	Nut wing 1/4"-20 ss	071404	1
6	Washer 5/16" i.d. X 3/4" o.d.	072173	1
7	Center rod SM/SMBW 4024 21" white Center rod SM/SMBW 4036 27" white Center rod SM/SMBW 4048 33" white Center rod SM/SMBW 4060 39" white	072870 072869 072880 072867	1
8	Element 4024 12" Element 4036 18" Element 4048 24" Element 4060 30"	074922 074923 074924 074925	8
9	Manifold 2000/4000 series 8 holes	073270	1
10	O-ring, lid	071439	1
11	Seal - valve rotor, tapered	071720	1
12	Rotor valve, Noryl w/seal	073370	1
13	O-ring 2-113	071435	1
14	Tank Bottom, SMBW	197130	1
15	Tank Bottom, SM	197126	1
16	Plug, PVC 2", SM only	071559	1
17	Handle SMBW rotor ss	190026	1
18	Handle extension b/w brass	070971	1
19	Handle stud bolt ss 1/4-20 x 1.75"	070979	1
20	Washer lock 1/4" ss	072172	1
21	Nut 1/4-20 ss Hex	071406	1
22	Vent tube 1/4" - 46" all models	075279	1
23	Vent tube screen cap	073691	1

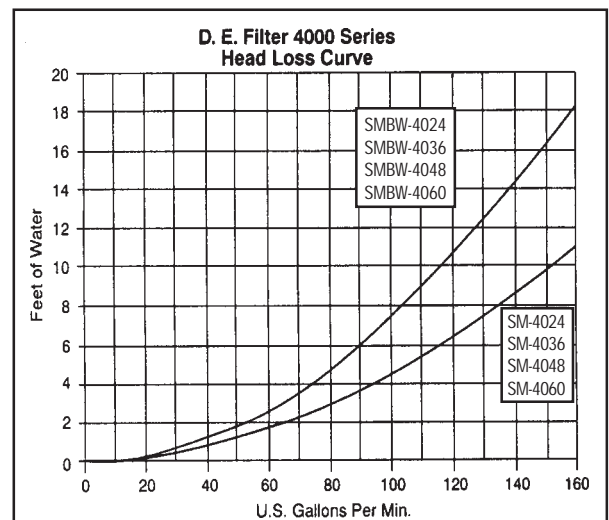
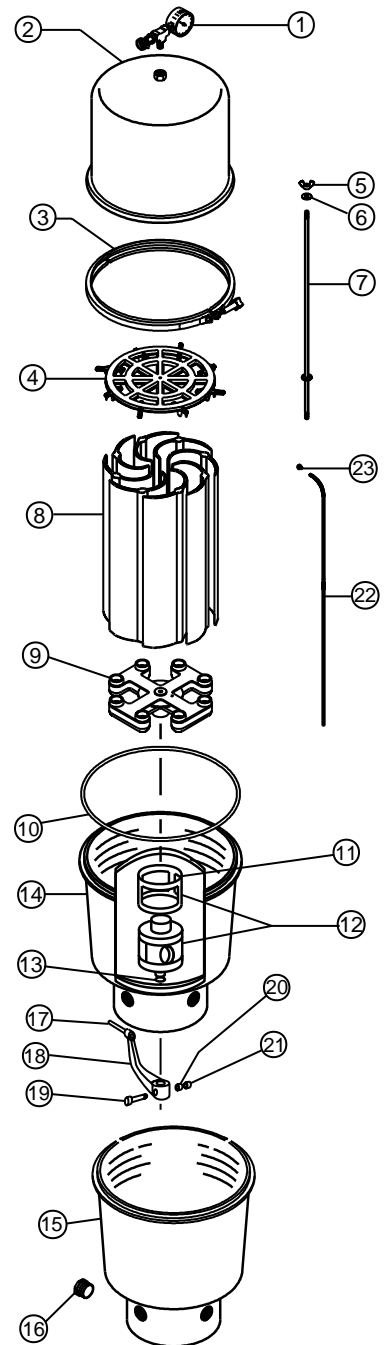

SMBW™ 4000 SERIES FILTER LIMITED WARRANTY

Your SMBW™ 4000 Series filter is a quality product of Pentair Pool Products which warrants that it is fit for the ordinary purposes for which such equipment is used, is adequately contained, packaged and labeled, and conforms to the representations made on the container or label. This warranty only applies to the original purchaser.

TANK AND TANK INTERNAL PARTS

The filter is warranted for a period of three years from date of installation. Tank internal parts are warranted for a period of one year from date of installation.

Tank failure due to chemical corrosion is not covered in this warranty.

Where the manufacturer has agreed under this warranty to repair or replace this unit there will be no charge to the purchaser for such services other than the normal shipping charges to and from the factory when such repairs or replacement occur within two years from the date of purchase.

THE ABOVE WARRANTY APPLIES ONLY IF THE FILTER IS INSTALLED AND OPERATED IN COMPLETE COMPLIANCE WITH THE INSTALLATION AND OPERATION MANUAL PROVIDED WITH EACH UNIT. Copies of this manual are available by writing the Pentair Pool Products' Customer Service at the address below.

Parts judged to be defective upon inspection by Pentair Pool Products will be repaired or replaced, F.O.B. Pentair Pool Products factory, free of charge, providing merchandise is returned freight prepaid to the Pentair Pool Products Customer Service department at the address below. All defective parts or equipment should be identified by serial number and packing slip and installation date together with a written description of the problem.

PENTAIR POOL PRODUCTS ASSUMES NO LIABILITY EXCEPT FOR THE REPAIR OR REPLACEMENT OF PARTS AS SPECIFIED ABOVE. NO ALLOWANCE WILL BE MADE FOR CONSEQUENTIAL DAMAGES, LABOR, TRANSPORTATION OR OTHER CHARGES IN THE REPAIR OR REPLACEMENT OF THE DEFECTIVE PARTS OR EQUIPMENT. Some states do not allow exclusion or limitation of incidental or consequential damages so the above may not apply to you.

NO PERSON IS AUTHORIZED TO MAKE ANY REPRESENTATION OR WARRANTY ON BEHALF OF PENTAIR POOL PRODUCTS OR ANY OF ITS DISTRIBUTORS OR DEALERS OTHER THAN AS SET FORTH HEREIN.

This warranty gives you specific legal rights, and you may also have other rights which vary from state to state.

Filter Serial No.



Because **reliability** matters most

Pentair Pool Products

1620 Hawkins Ave., Sanford, NC 27330 • (919) 774-4151
10951 W. Los Angeles Ave., Moorpark, CA 93021 • (805) 523-2400

SAVE THESE INSTRUCTIONS.