

SPECIFICATIONS	
MODEL:	8' Plunge
SHELL WEIGHT:	4000 LBS.
WATER WEIGHT:	23517 LBS.
TOTAL SHELL & WATER WEIGHT:	27517 LBS.
WATER VOLUME:	377 Cu.Ft.
WATER GALLONS:	2820 GAL.
SURFACE AREA:	50.3 SQ. FT.
ICC ES LISTED #:	PMG-1161

SKID SUPPORT STRUCTURE* BONDED TO SPA	
*SKIDS SUPPLIED BY NESPA	
LIGHT NICHE	
	Nexus LED Light
SIDEWALL SUCTION	
	5" HIGH FLOW SUCTIONS Waterway 640-357xV Super Hi-Flo Suction Assy. Max Flow 180 GPM Complies w/ ANSI Code ASME A112.19.8-2008 & VGB 2008
RETURN	
	INLET FITTINGS 1-1/2" WALL TYPE W/ EYEBALL HYDROAIR #10-3500 COMPLIES W/ ANSI CODE ASME A112.19.8-08 UL APPROVED
FILL	
	INLET FITTINGS 1-1/2" WALL TYPE W/ EYEBALL HYDROAIR #10-3500 COMPLIES W/ ANSI CODE ASME A112.19.8-08 UL APPROVED

SPECIFICATIONS	
MODEL:	Surge Tank
SHELL WEIGHT:	1000 LBS.
WATER WEIGHT:	2751 LBS.
TOTAL SHELL & WATER WEIGHT:	3751 LBS.
WATER VOLUME:	44.1 Cu.Ft.
WATER GALLONS:	330 GAL.
SURFACE AREA:	17.7 SQ. FT.
ICC ES LISTED #:	PMG-1161

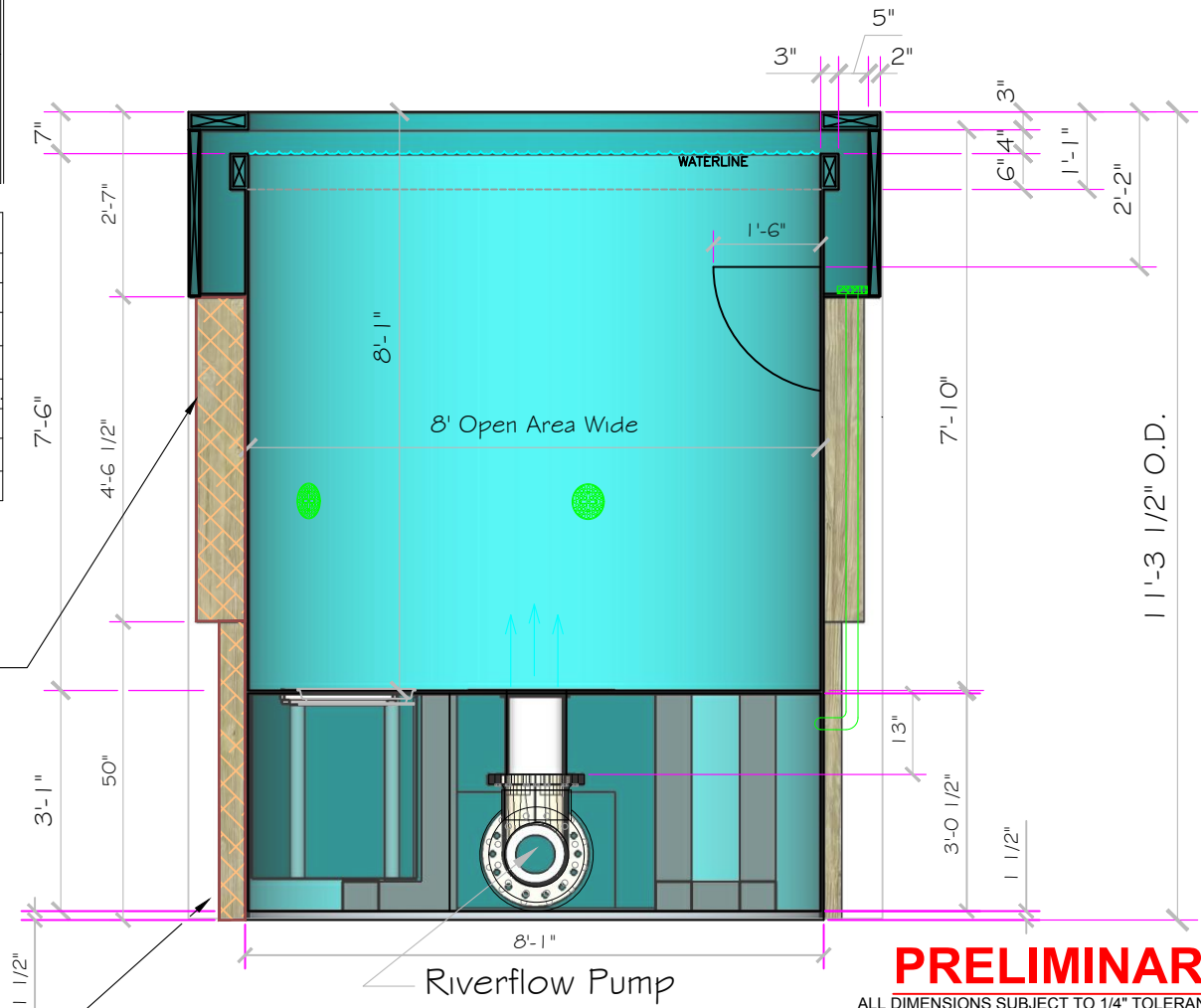
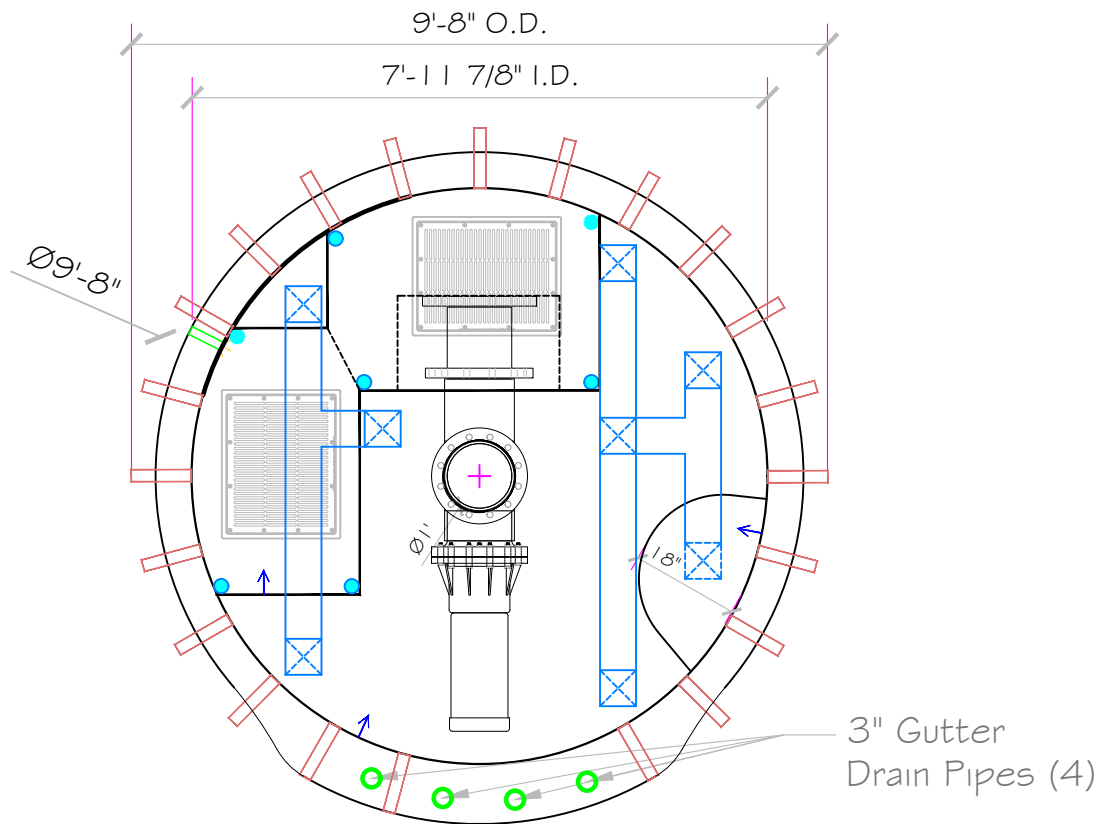

PRELIMINARY
ALL DIMENSIONS SUBJECT TO 1/4" TOLERANCES

NESPA ENTERPRISES INC.
2800 Richter Ave. Suite C Oroville, CA 95966
Office: (530) 534-9910 Fax: (530) 534-9915
E-Mail: jim@tiledspas.com Web Site: www.tiledspas.com



If printing as a PDF:
Page Scaling: None
DWG NAME: MEEHAN PLUNGE

SCALE: 3/8" = 1"
DATE: 6/29/2015

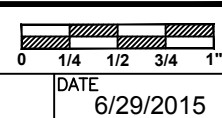

DWG TYPE: Plunge
SHEET: PAGE 1 OF 9

These drawings, concepts, and details contained herein are the original proprietary designs of NESPA ENTERPRISES INC., developed over many years of experience in the industry and as such are protected by the copyright laws of the United States Government. Reproduction of any of the above without written permission to do so by NESPA ENTERPRISES INC., is illegal.

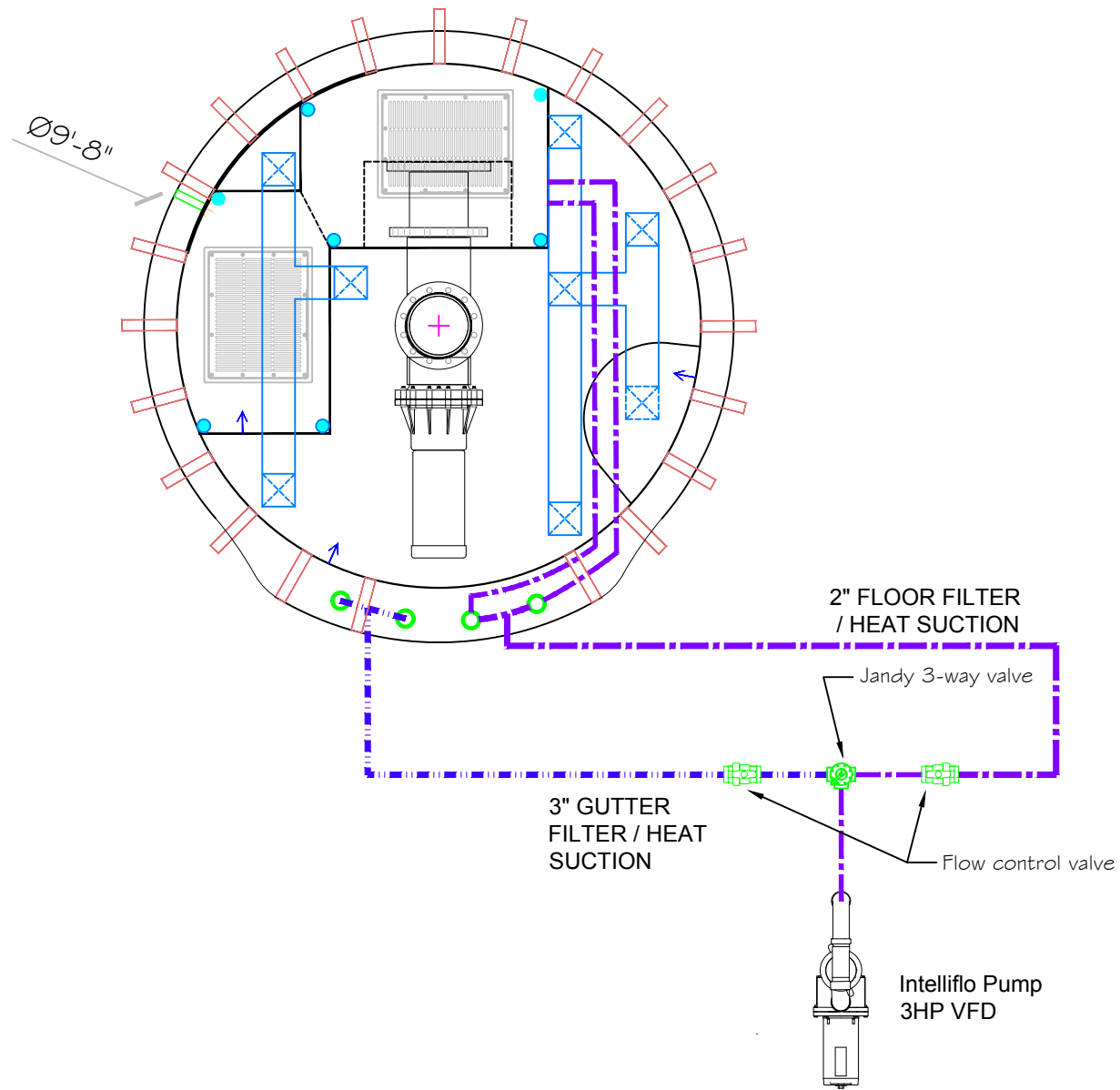

PRELIMINARY

ALL DIMENSIONS SUBJECT TO 1/4" TOLERANCES

These drawings, concepts, and details contained herein are the original proprietary designs of **NESPA ENTERPRISES INC.**, developed over many years of experience in the industry and as such are protected by the copyright laws of the United States Government. Reproduction of any of the above without written permission to do so by **NESPA ENTERPRISES INC.**, is illegal.

NESPA ENTERPRISES INC.

2800 Richter Ave. Ste. C Oroville, CA 95966

Office: (530) 534-9910

Fax: (530) 534-9915

E-Mail: jim@tiledspas.com Web Site: www.tiledspas.com



If printing as a PDF:

Page Scaling: None

SCALE

3/8" = 1'

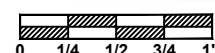

DWG TYPE

Plunge Suction Plumbing

DWG NAME

MEEHAN PLUNGE

DATE

6/23/2015

SHEET

PAGE 2 OF 9

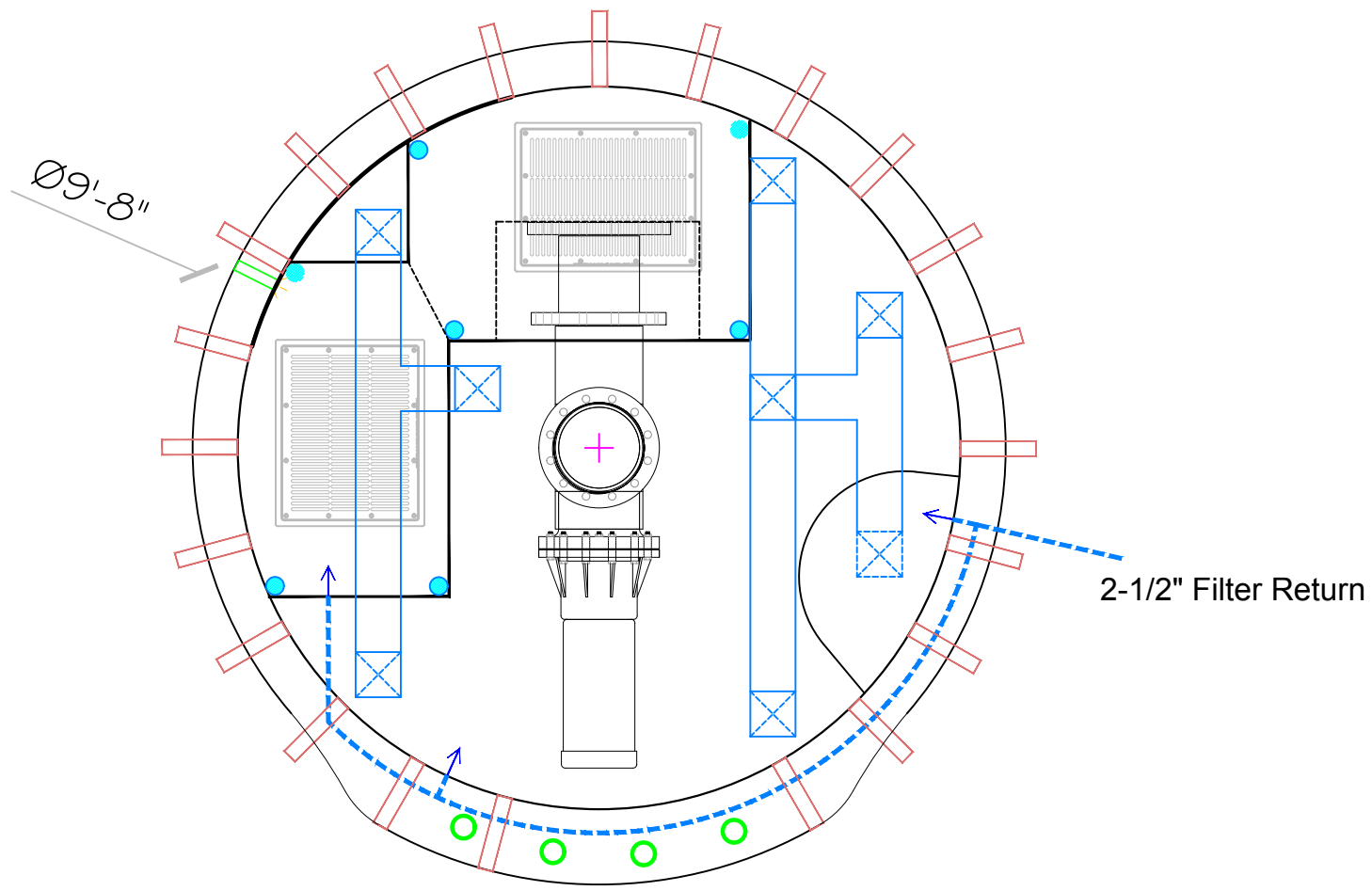

PRELIMINARY
 ALL DIMENSIONS SUBJECT TO 1/4" TOLERANCES

These drawings, concepts, and details contained herein are the original proprietary designs of **NESPA ENTERPRISES INC.**, developed over many years of experience in the industry and as such are protected by the copyright laws of the United States Government. Reproduction of any of the above without written permission to do so by **NESPA ENTERPRISES INC.**, is illegal.

NESPA ENTERPRISES INC.
 2800 Richter Ave. Ste. C Oroville, CA 95966
 Office: (530) 534-9910 Fax: (530) 534-9915
 E-Mail: jim@tiledspas.com Web Site: www.tiledspas.com



If printing as a PDF:
 Page Scaling:

SCALE
 1/2" = 1'
 0 1/4 1/2 3/4 1"

DWG TYPE
 Plunge Return Plumbing

DWG NAME
 MEEHAN PLUNGE

DATE
 6/23/2015

SHEET
 PAGE 3 OF 9

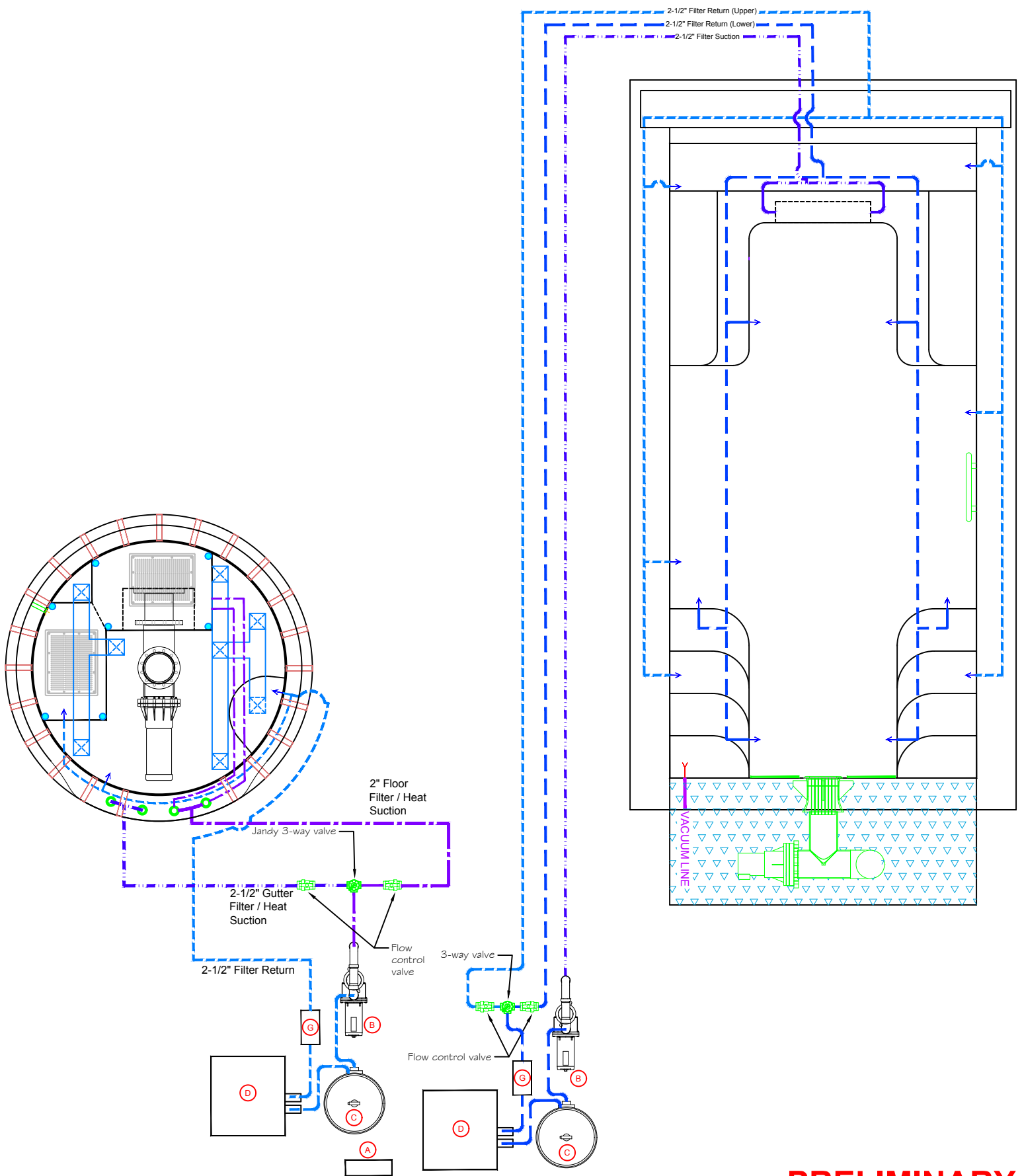

PRELIMINARY

ALL DIMENSIONS SUBJECT TO 1/4" TOLERANCES

NESPA ENTERPRISES INC.

2800 Richter Ave. Suite C Oroville, CA 95966

Office: (530) 534-9910 Fax: (530) 534-9915

E-Mail: jim@tiledspas.com Web Site: www.tiledspas.com



If printing as a PDF:

Page Scaling:

DWG NAME

MEEHAN PLUNGE

SCALE
1/4" = 1'

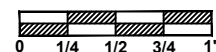

DWG TYPE
Plumbing Layout

DATE
6/23/2015

SHEET
PAGE 4 OF 9

These drawings, concepts, and details contained herein are the original proprietary designs of NESPA ENTERPRISES INC., developed over many years of experience in the industry and as such are protected by the copyright laws of the United States Government. Reproduction of any of the above without written permission to do so by NESPA ENTERPRISES INC., is illegal.

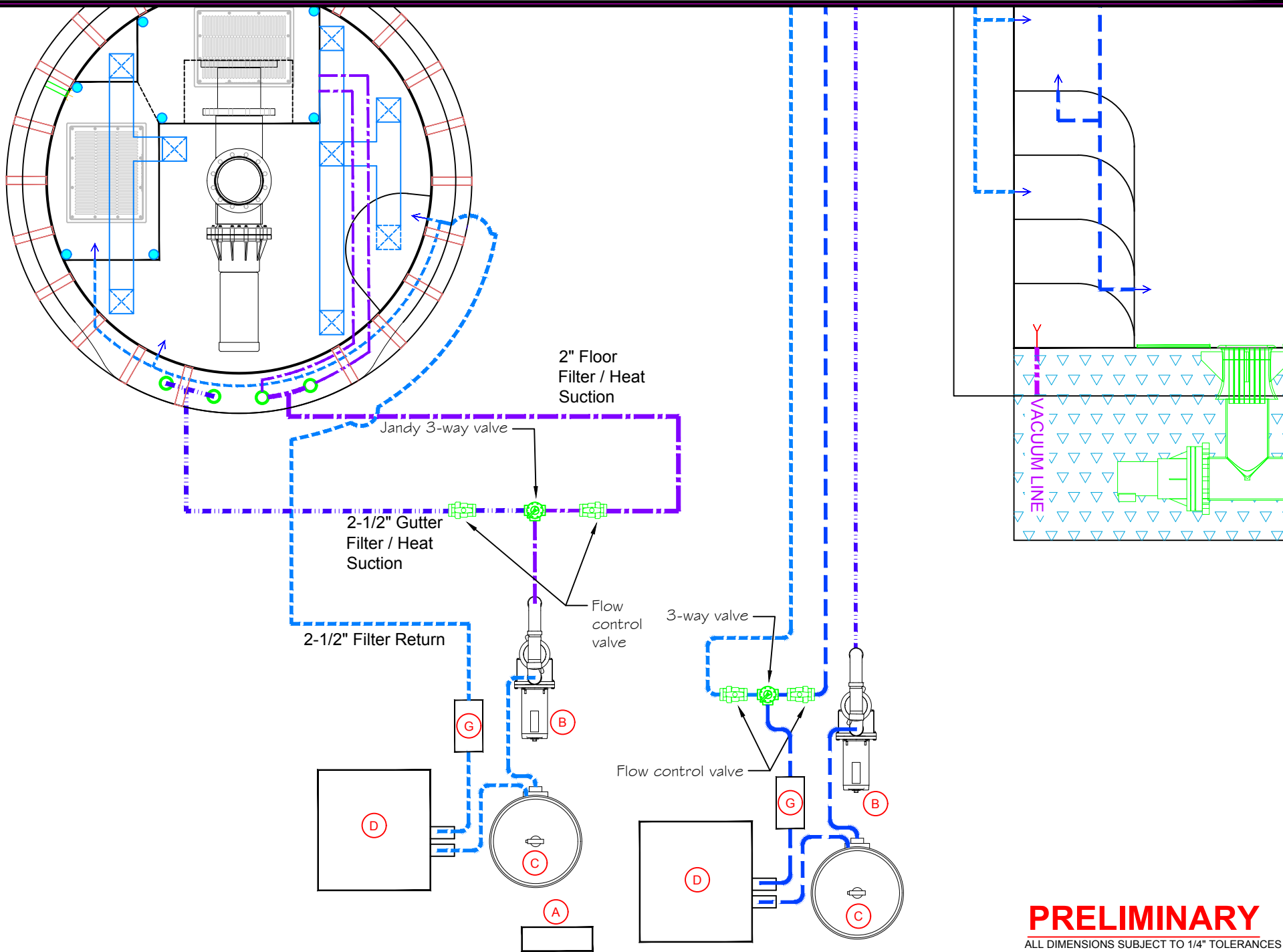

PRELIMINARY

ALL DIMENSIONS SUBJECT TO 1/4" TOLERANCES

These drawings, concepts, and details contained herein are the original proprietary designs of **NESPA ENTERPRISES INC.**, developed over many years of experience in the industry and as such are protected by the copyright laws of the United States Government. Reproduction of any of the above without written permission to do so by **NESPA ENTERPRISES INC.**, is illegal.

NESPA ENTERPRISES INC.
 2800 Richter Ave. Ste. C Oroville, CA 95966
 Office: (530) 534-9910 Fax: (530) 534-9915
 E-Mail: jim@tiledspas.com Web Site: www.tiledspas.com



If printing as a PDF:

Page Scaling:

SCALE
 3/8" = 1'

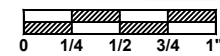

DWG TYPE
 Plumbing Layout (2)

DWG NAME
 MEEHAN PLUNGE

DATE
 6/23/2015

SHEET
 PAGE 5 OF 9

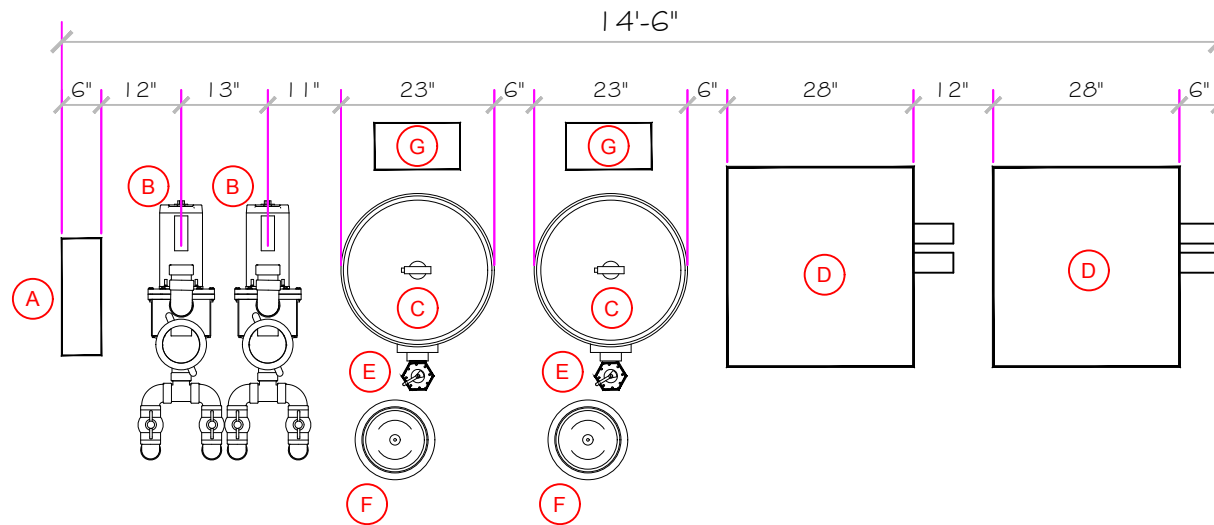

EQUIPMENT LIST

ITEM	DESCRIPTION	MANUFACTURER	CATALOG NO.	QTY.
A	Intellitouch I9s plus 3 Dual Body Control System.	PENTAIR	x	1
B	Pentair Whisperflo XF 3HP	PENTAIR	022030	2
C	Pentair DE Filter FN5P48	PENTAIR	180008	2
D	Raypak Digital Propane Gas Heater R406A K BTU	RAYPAK	Ray-15-0205	2
E	Pentair DE Multiport Valve	PENTAIR	261055	2
F	Pentair Separation Tank 100 (optional)	PENTAIR	SEP 100	2
G	Delzone Eclipse UV Ozone Generator	Delzone	x	2

PRELIMINARY

ALL DIMENSIONS SUBJECT TO 1/4" TOLERANCES

These drawings, concepts, and details contained herein are the original proprietary designs of **NESPA ENTERPRISES INC.**, developed over many years of experience in the industry and as such are protected by the copyright laws of the United States Government. Reproduction of any of the above without written permission to do so by **NESPA ENTERPRISES INC.**, is illegal.

NESPA ENTERPRISES INC.
 2800 Richter Ave. Ste. C Oroville, CA 95966
 Office: (530) 534-9910 Fax: (530) 534-9915
 E-Mail: jim@tiledspas.com Web Site: www.tiledspas.com



If printing as a PDF:

Page Scaling:

SCALE
N/A

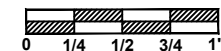

DWG TYPE
Spa & Plunge EQ

DWG NAME
MEEHAN PLUNGE

DATE
4/20/2015

SHEET
PAGE 6 OF 9

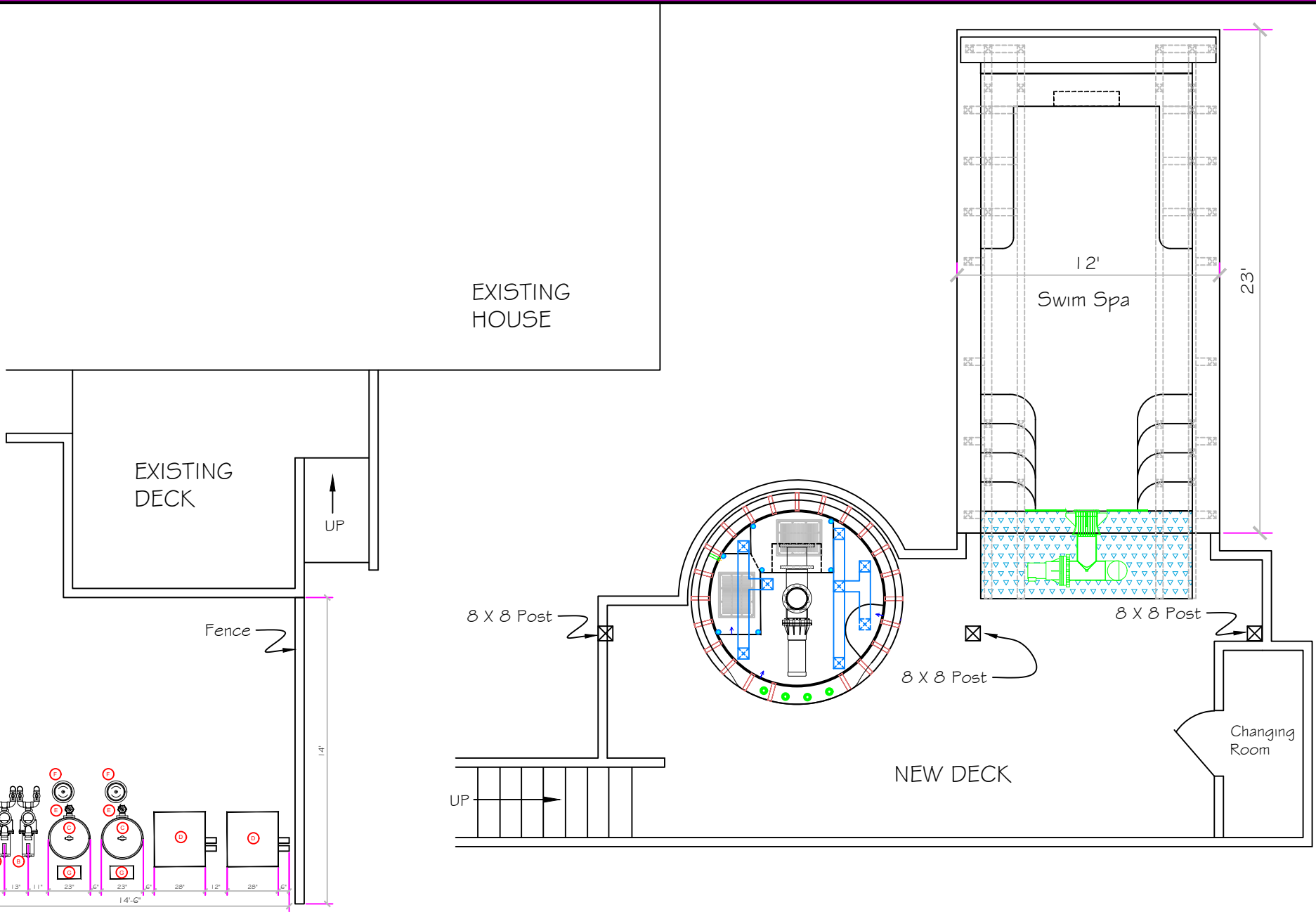

PRELIMINARY
 ALL DIMENSIONS SUBJECT TO 1/4" TOLERANCES

These drawings, concepts, and details contained herein are the original proprietary designs of **NESPA ENTERPRISES INC.**, developed over many years of experience in the industry and as such are protected by the copyright laws of the United States Government. Reproduction of any of the above without written permission to do so by **NESPA ENTERPRISES INC.**, is illegal.

NESPA ENTERPRISES INC.
 2800 Richter Ave. Ste. C Oroville, CA 95966
 Office: (530) 534-9910 Fax: (530) 534-9915
 E-Mail: jim@tiledspas.com Web Site: www.tiledspas.com

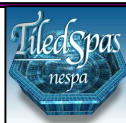

If printing as a PDF:
 Page Scaling:

SCALE: N/A
 0 1/4 1/2 3/4 1"

DWG TYPE: Spa & Plunge Layout
 SHEET: PAGE 7 OF 9
 DATE: 5/22/2015

DWG NAME: MEEHAN PLUNGE

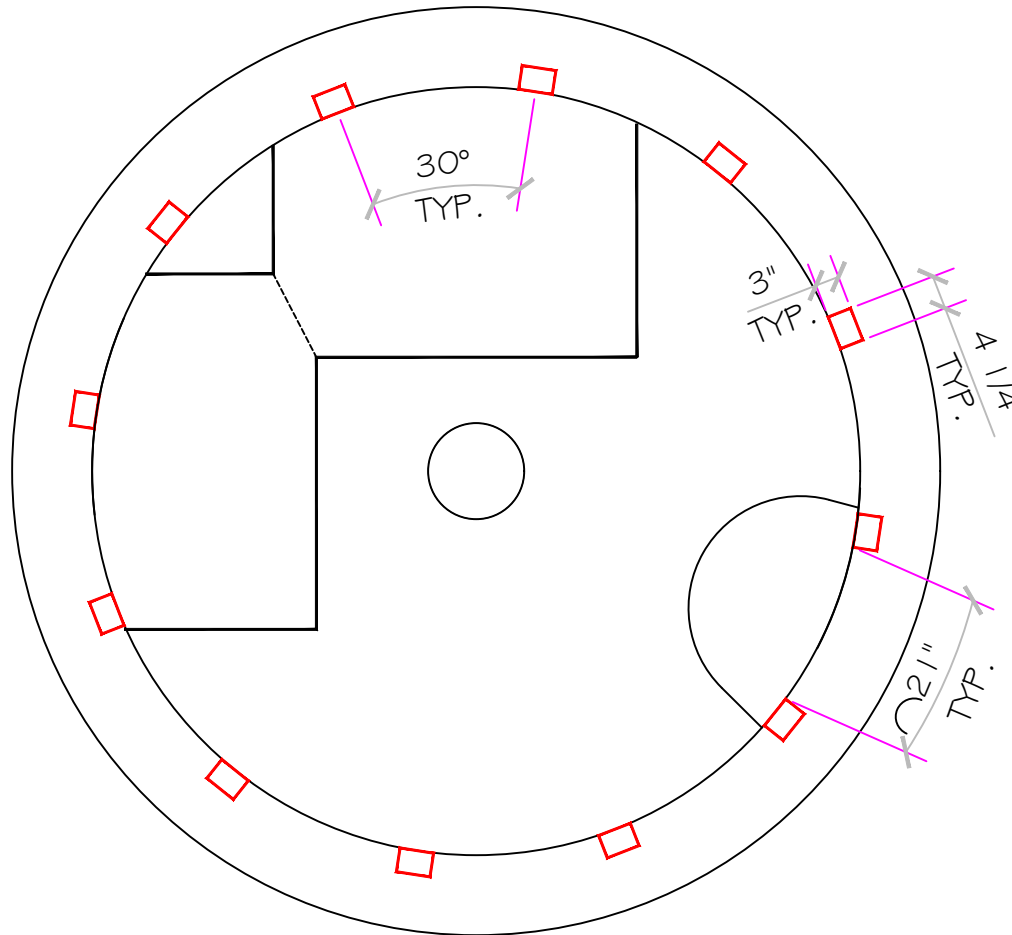

PRELIMINARY

ALL DIMENSIONS SUBJECT TO 1/4" TOLERANCES

These drawings, concepts, and details contained herein are the original proprietary designs of **NESPA ENTERPRISES INC.**, developed over many years of experience in the industry and as such are protected by the copyright laws of the United States Government. Reproduction of any of the above without written permission to do so by **NESPA ENTERPRISES INC.**, is illegal.

NESPA ENTERPRISES INC.

2800 Richter Ave. Ste. C Oroville, CA 95966

Office: (530) 534-9910

Fax: (530) 534-9915

E-Mail: jim@tiledspas.com Web Site: www.tiledspas.com



If printing as a PDF:

Page Scaling:

SCALE

1/2" = 1'

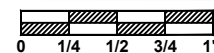

DWG TYPE

Spacers

DWG NAME

MEEHAN PLUNGE

DATE

5/22/2015

SHEET

PAGE 8 OF 9

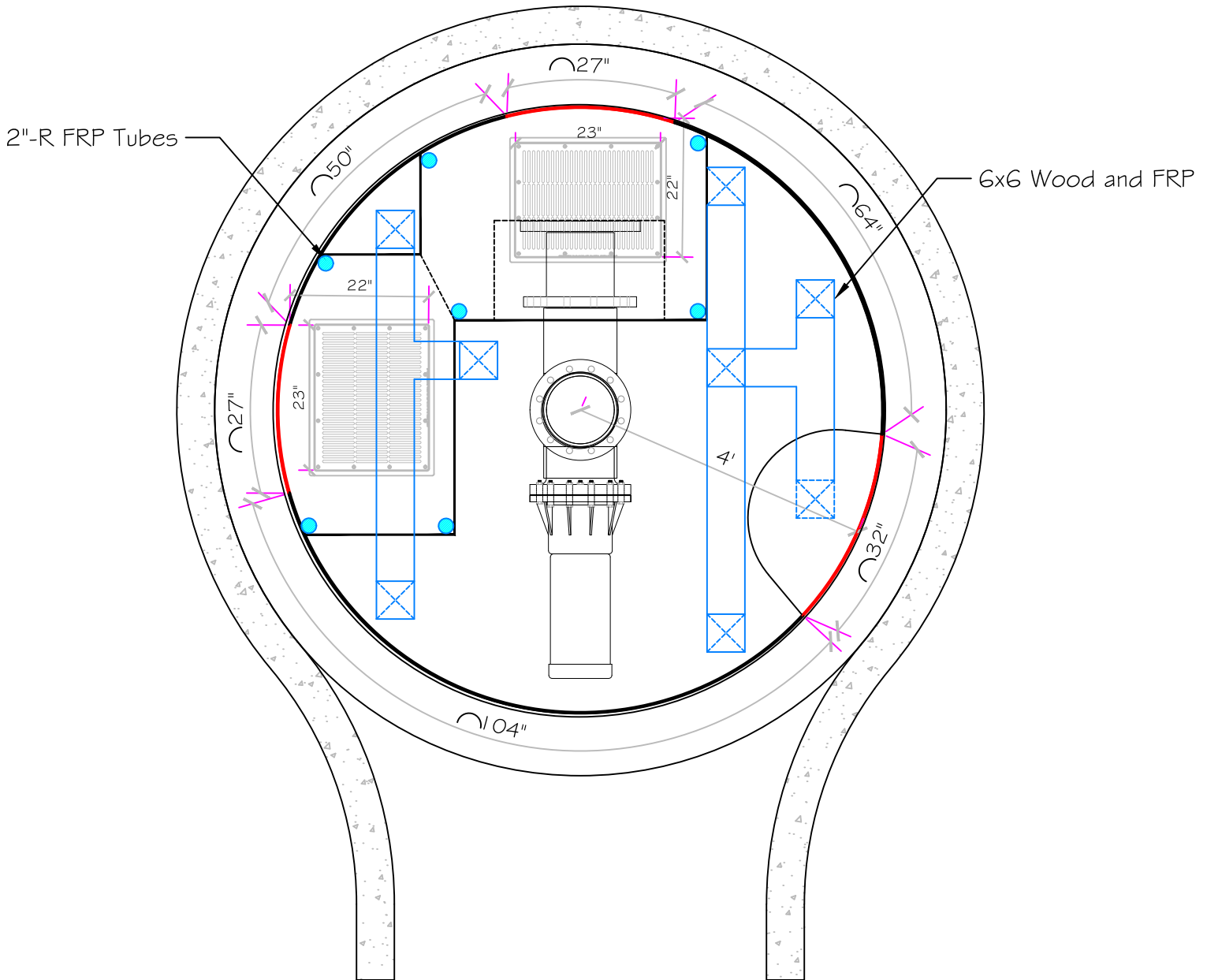

PRELIMINARY

ALL DIMENSIONS SUBJECT TO 1/4" TOLERANCES

NESPA ENTERPRISES INC.

2800 Richter Ave. Suite C Oroville, CA 95966

Office: (530) 534-9910

Fax: (530) 534-9915

E-Mail: jim@tiledspas.com Web Site: www.tiledspas.com



If printing as a PDF:

Page Scaling:

SCALE

1/2" = 1'

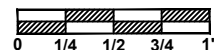

DWG TYPE

Surge Tank

DWG NAME

MEEHAN PLUNGE Surge Tank

DATE

6/23/2015

SHEET

PAGE 9 OF 9

These drawings, concepts, and details contained herein are the original proprietary designs of [NESPA ENTERPRISES INC.](http://www.tiledspas.com), developed over many years of experience in the industry and as such are protected by the copyright laws of the United States Government. Reproduction of any of the above without written permission to do so by [NESPA ENTERPRISES INC.](http://www.tiledspas.com), is illegal.

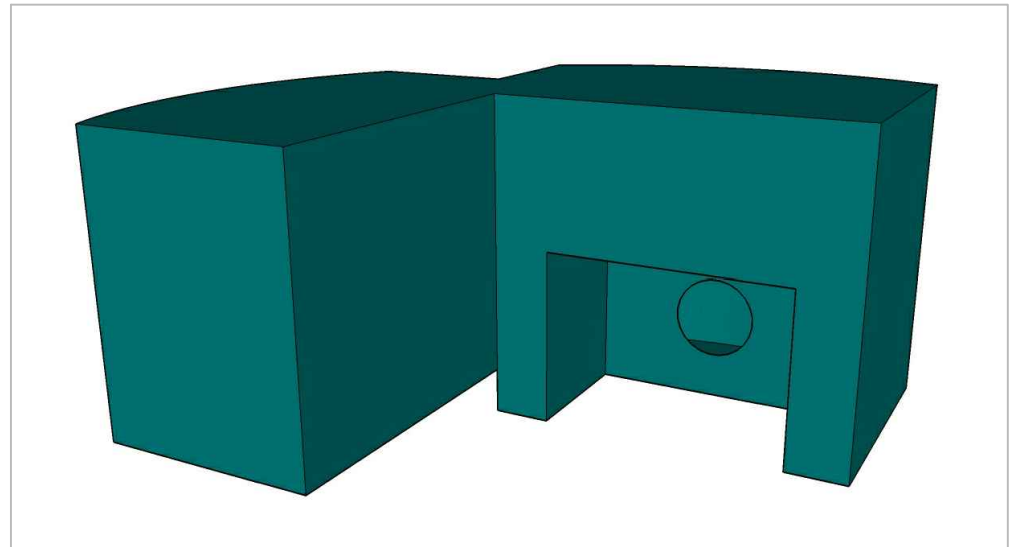
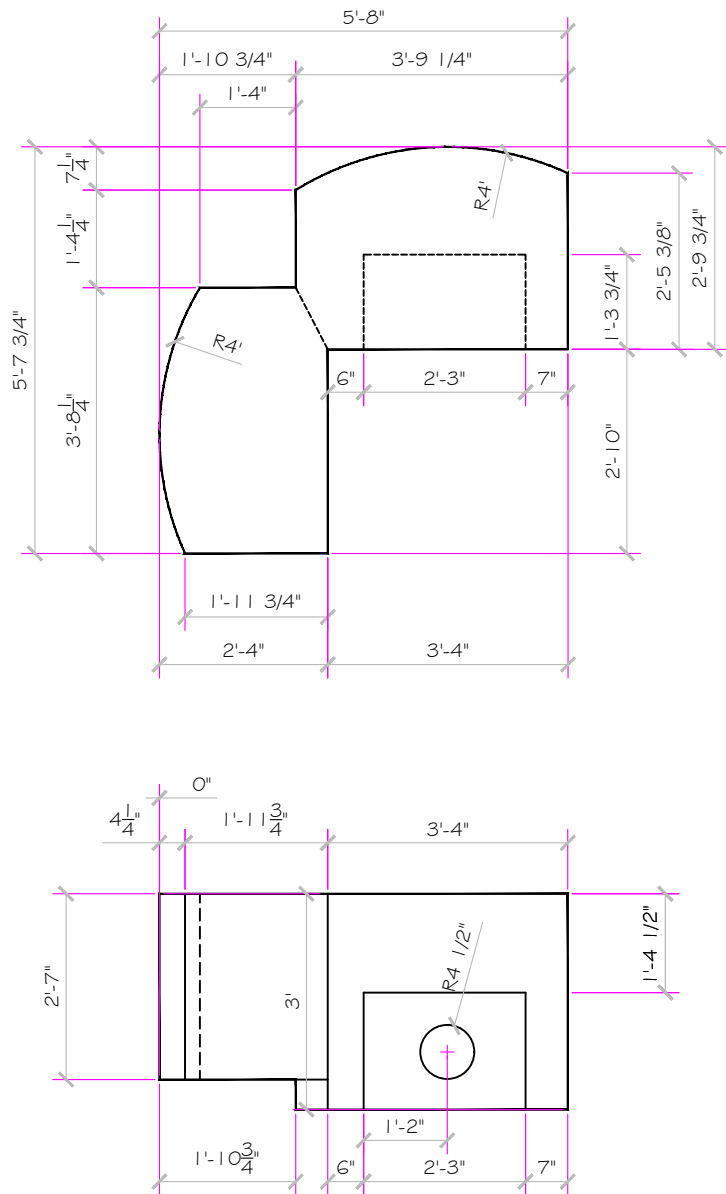

PRELIMINARY

ALL DIMENSIONS SUBJECT TO 1/4" TOLERANCES

These drawings, concepts, and details contained herein are the original proprietary designs of **NESPA ENTERPRISES INC.**, developed over many years of experience in the industry and as such are protected by the copyright laws of the United States Government. Reproduction of any of the above without written permission to do so by **NESPA ENTERPRISES INC.**, is illegal.

NESPA ENTERPRISES INC.

2800 Richter Ave. Ste. C Oroville, CA 95966

Office: (530) 534-9910

Fax: (530) 534-9915

E-Mail: jim@tiledspas.com Web Site: www.tiledspas.com



If printing as a PDF:

Page Scaling: None

SCALE

3/8" = 1'

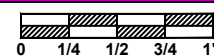

DWG TYPE

Surge Tank Shop

DWG NAME

MEEHAN PLUNGE

DATE

5/22/2015

SHEET

PAGE 1 OF 1

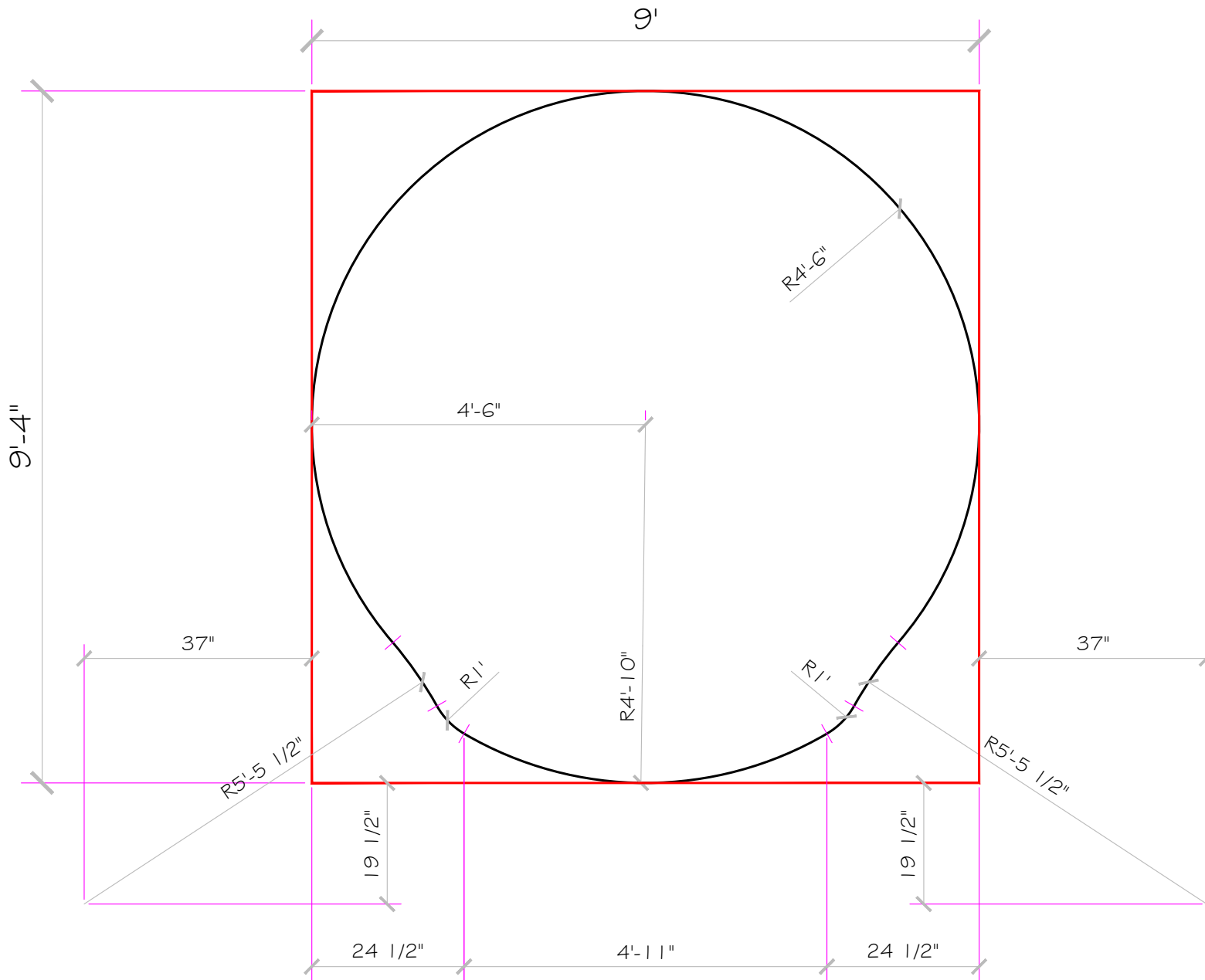

PRELIMINARY

ALL DIMENSIONS SUBJECT TO 1/4" TOLERANCES

These drawings, concepts, and details contained herein are the original proprietary designs of **NESPA ENTERPRISES INC.**, developed over many years of experience in the industry and as such are protected by the copyright laws of the United States Government. Reproduction of any of the above without written permission to do so by **NESPA ENTERPRISES INC.**, is illegal.

NESPA ENTERPRISES INC.
 2800 Richter Ave. Ste. C Oroville, CA 95966
 Office: (530) 534-9910 Fax: (530) 534-9915
 E-Mail: jim@tiledspas.com Web Site: www.tiledspas.com



If printing as a PDF:

Page Scaling:

SCALE
 1/2" = 1'

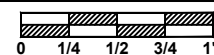

DWG TYPE

Surge Tank PAD

DWG NAME

MEEHAN PLUNGE

DATE

6/24/2015

SHEET

PAGE 1 OF 1