



NESPA
TILED SPAS

Production Booklet

for

PERLMUTTER SPA

2800 Richter Ave. Suite C, Oroville, CA 95965 • **voice:** (530)534-9910
fax: (530)534-9915 • **email:** sales@tiledspas.com • **website:** www.tiledspas.com



RECOMMENDED MAINTENANCE

Please Note:

These are only recommended guidelines to care for a Nespa all tiled spa. Local codes may require additional procedures, therefore consult with a pool professional that is LA county Health Department certified for more information on local codes and requirements.

SPA SURFACE

Your spa tile is acid resistant and frost-proof. The Tile does not absorb germs or algae. Tile does not stain and is very easy to clean. Color does not fade or lose its luster. All grouts are epoxy based and are extremely durable. To remove scum line use soft nylon brush and small amounts of biodegradable soaps. Do not use abrasive brushes or chemicals.

MAINTENANCE

A. CHEMICALS:

- 1) It is important to maintain a chlorine residual of 2 PPM in the spa. That residual can be provided by chlorine or bromine.
- 2) It is recommended to use Bromine or dichlor (granular) forms of chlorine. If bromine Tabs are used we suggest floating or inline dispenser.
- 3) Never use acid to lower Ph in the tile spa.
- 4) Never use trichlor chlorine (1" or 3") tablets in the Nespa spas.
- 5) Never place tablets in skimmer basket.

B. DRAINING THE SPA:

- 1) It is recommended to drain the spa at least once every 2 months depending on bath load and water clarity.
- 2) The spa should be drained through valve exiting re-circulation pump in the spa equipment room or sump pump.
- 3) Note: Use caution to drain spa in the winter months or rainy season when water table is at its highest. It is possible for the spa to float due to hydraulic pressure from surrounding water table. We advise that you consult with your local spa specialist prior to draining the spa.

C. SPA EQUIPMENT:

- 1) Clean filter cartridge at least once every month, or when needed; i.e., if water clarity does not improve after several days.
- 2) Keep area free and clear from leaves and debris build-up.
- 3) Keep area free and clear from flooding.

D. SPA LIGHT:

- 1) Spa light has to be on GFCI circuit. It is controlled at spa side with ON/OFF.

E. TILE SERVICING:

- 1) Contact manufacture when servicing tile or grout. @ (530) 534-9910

1		2		3		4	
ZONE	REV	PG.	REVISION DESCRIPTION			DATE	
ALL	0	ALL	INITIAL DESIGN			10-31-06	
ALL	1	ALL	Revised DESIGN added Plumbing			11-02-06	
ALL	2	ALL	Revised DESIGN - SIZE			02-16-07	
ALL	3	2	Revised booster suction			03-01-07	

SPECIFICATIONS	
DRY WEIGHT:	2000 LBS.
TOTAL WEIGHT:	14784 LBS.
WATER:	1533.4 GAL.
VOLUME:	205 Cu.Ft.
WEIGHT:	12784 LBS.
SURFACE AREA:	76 SQ. FT.
IAPMO#:	1138
FDA#:	2030305

**SKID SUPPORT
STRUCTURE* BONDED
TO SPA**

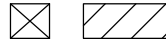

*SKIDS SUPPLIED
BY NESPA

JET  **FILL** 

SUCTION 
5" HIGH FLOW SUCTIONS
8.39 SQ. IN. OPEN AREA
208 GPM AT 1.5 FT/SEC
COMPLIES W/ ANSI CODE A112.19
UL APPROVED

EQUALIZER 
4" 3.61 SQ. IN. OPEN AREA,
COMPLIES W/ ANSI CODE A112.19

MAIN DRAIN
 9" X 9" FRAME,
49 SQ. IN. OPEN AREA,
299 GPM @ 1 1/2 FT/SEC

LIGHT NICHE
 SPA BRIGHT, 120 V,
100 WATT, 50' CORD,
U.L. APPROVED

SKIMMER
 SURFACE SKIMMER
W/ EQUALIZER,
NSF APPROVED

NESPA ENTERPRISES INC.
2800 Richter Ave. Suite C
Oroville, CA 95966
Office: (530) 534-9910
Fax: (530) 534-9915
E-Mail: sales@tiledspas.com
Web Site: www.tiledspas.com
ALL DIMENSIONS SUBJECT TO 1/4" TOLERANCES

10' LEGACY

OCEANSIDE

These drawings, concepts, and details contained herein are the original proprietary designs of NESPA ENTERPRISES, developed over many years of experience in the pool and spa industry and as such are protected by the copyright laws of the United States Government. Reproduction of any of the above without written permission to do so by NESPA ENTERPRISES, is illegal.

SIZE	3/1/2007	DWG NO.	PERLMUTTER	REV	0
MISC.	SHEET		TITLE PAGE		

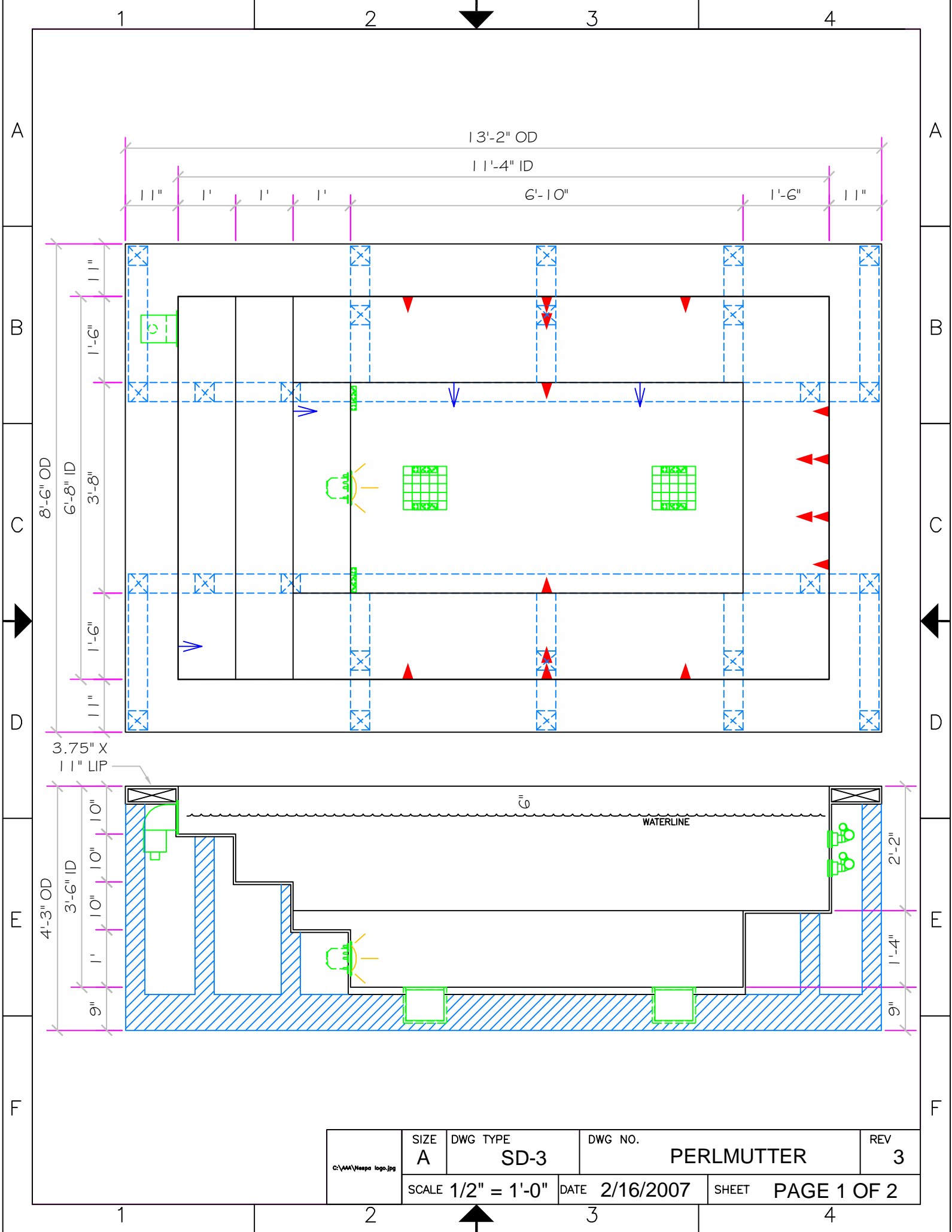

c:\vmm\Neapa logo.jpg	SIZE A	DWG TYPE SD-3	DWG NO. PERLMUTTER	REV 3
	SCALE 1/2" = 1'-0"		DATE 2/16/2007	SHEET PAGE 1 OF 2

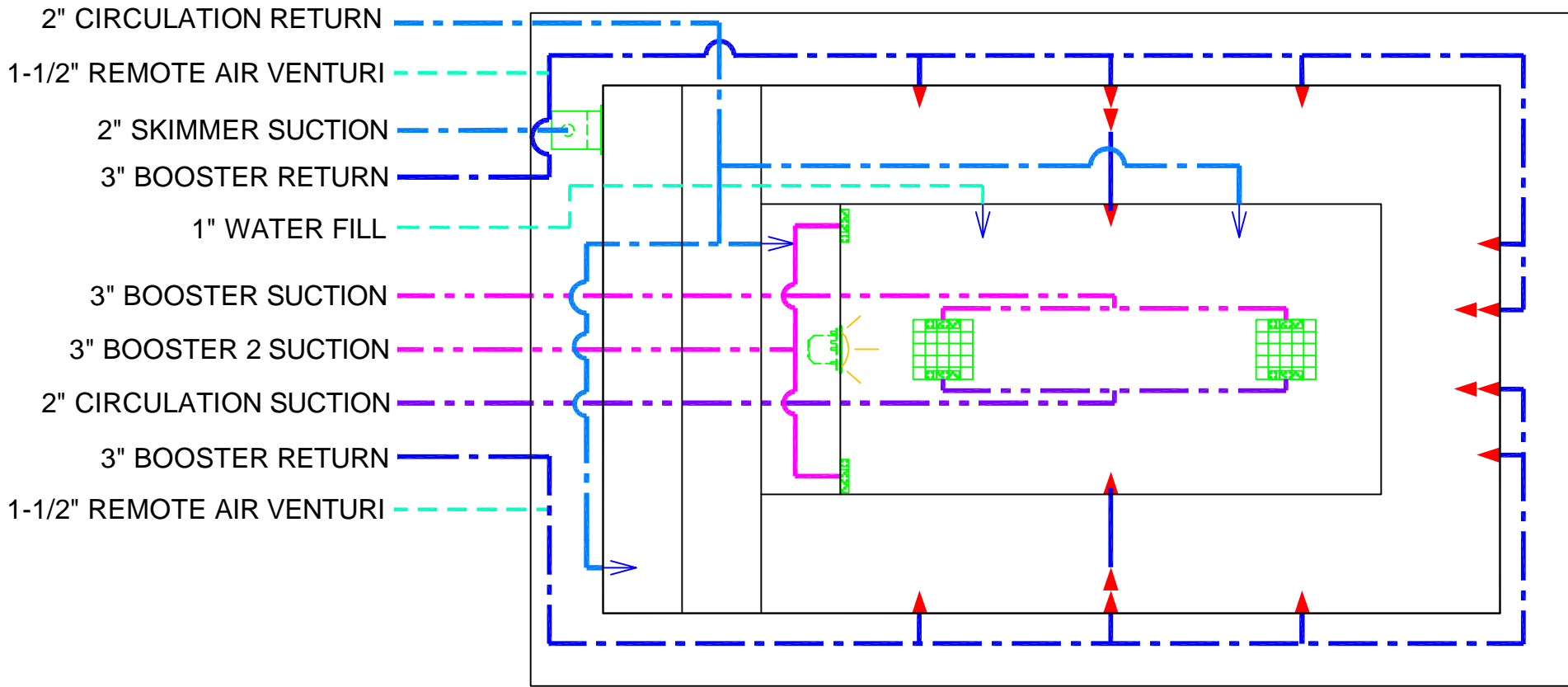
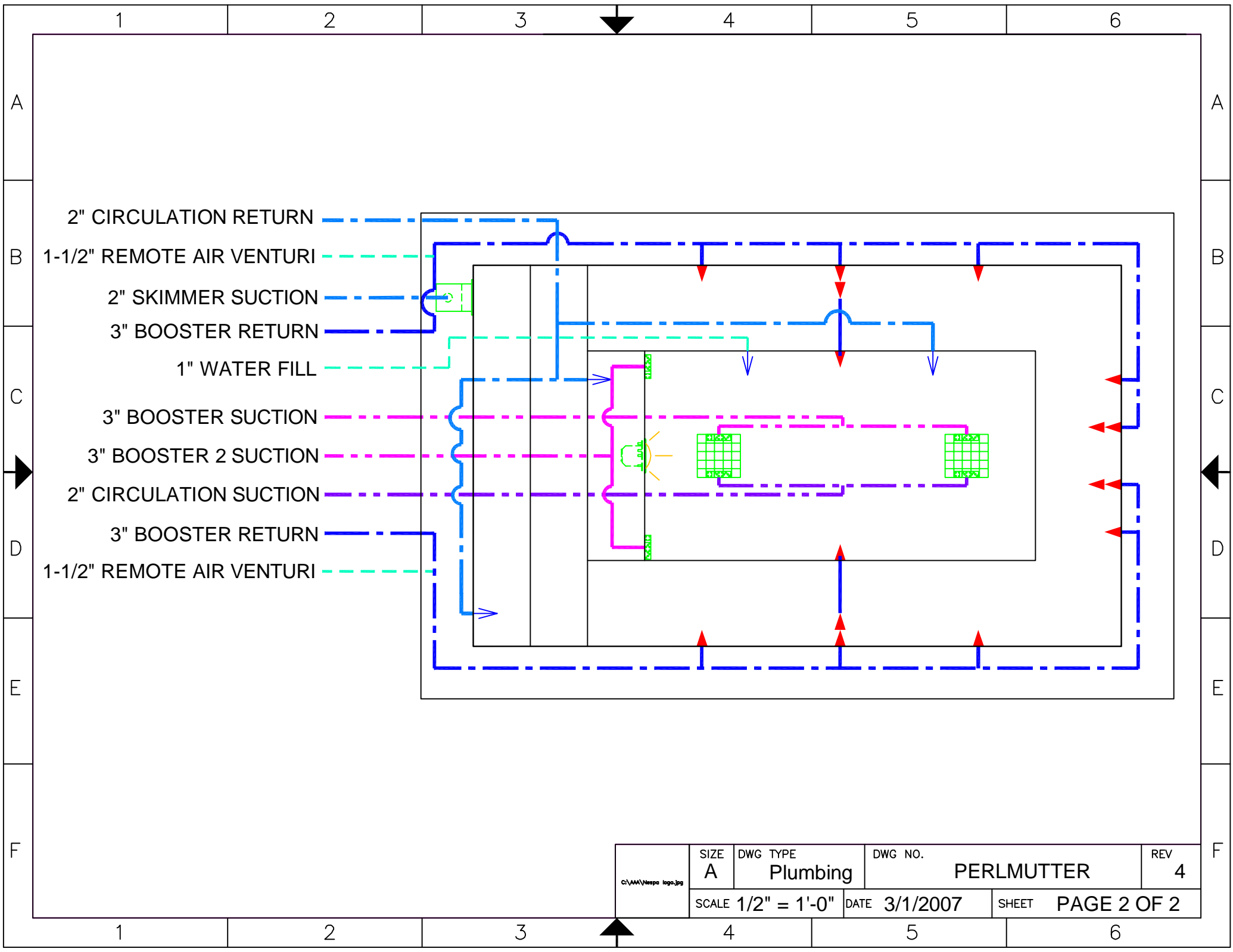

	SIZE A	DWG TYPE Plumbing	DWG NO. PERLMUTTER	REV 4
	SCALE 1/2" = 1'-0"		DATE 3/1/2007	SHEET PAGE 2 OF 2

STANDARD NESPA IN-GROUND INSTALLATION INSTRUCTIONS

SET-UP AND EXCAVATION:

- 1) In order to determine how to excavate for your spa or swim spa, measure spas inside dimension (I.D.) and add 8" to all sides. This 8" clearance is to accommodate jet and suction plumbing. This 8" clearance can change or be reduced upon request. Note: skimmer location, this area may have to be larger than 8". If you have questions call us. (888) 479-4677.
- 2) Hole depth is determined by spa's outside height dimension. This height may vary depending if spa has skids or no skids. Also consider the finish surrounding deck elevations, thickness of the finish material on spa upper horizontal lip. This material can be tile, stone, concrete or brick.
- 3) Preplumb spa before it goes into the hole.
- 4) Spa should sit on level 3 1/2" thick reinforced concrete pad.
- 5) Install spa into the hole on top of concrete pad. Do not hold onto pipes. Use caution with suction and jet plumbing when lowering into hole. **DO NOT STRESS FITTINGS !**
- 6) Check site reference points for proper spa positioning (i.e., squaring to house, garage, etc.).
- 7) Shim to level spa. Shim with non-compression able material.
- 8) Dry pack with cement gaps that have been created when shimming spa level.
- 9) Connect pipes to tees if preplumbed. After electrical conduit is connected to light niche, water test spa before back filling with sand.
- 10) All Nespa products are water tested prior to leaving factory.

ELECTRICAL:

- 1) All electrical connections to spa or equipment should comply with the national electrical code. (NEC)
- 2) Connect electrical conduit to light niche. This work should be done or reviewed by a licensed electrician.
- 3) To install spa light you will need to include inside the PVC conduit to the light niche a solid #8 coated copper wire. (If you are use brass conduit, internal bond wire is not required.) This bond wire should be pulled with the light cord at the same time. This bond wire needs to be attached to the internal bonding lug of the light niche. An approved encapsulate should be applied to bond wire connection in niche.
- 4) An external #8 copper wire shall be connected to the external bonding lug on the rear of the light niche. This copper wire can then be used for additional bonding requirements (i.e., handrails or any other metallic object within 5' of the spa.

PLUMBING:

- 1) When plumbing a Nespa it is important to properly size the plumbing. We highly recommend that you follow the pump manufacturer's pipe sizing requirements.
Example is spas within 50' of equipment, a 2 1/2" suction, a 2 1/2" return would be used.
- 2) The air venturi should be hartford loop adjacent to spa shell and air entry point can be located next to spa or remotely at equipment.
- 3) Fill spa with water and test the system for leaks.

SAND BACK FILL:

- 1) With water in spa, back-fill around spa perimeter with dry plaster sand and wet wash with hydraulic attachment to hose. Let set for one hour and hydraulic dry again. Be sure water level in spa is at the highest level. Any questions please call us. (888) 479-4677.

NESPA ENTERPRISES INC.

2800 Richter Ave. Suite E

Oroville, CA 95966

Office: (888) 479-4677 Fax: (530) 534-9915

E-Mail: nespa@pacbell.net www.tiledspas.com

IN-GROUND

INSTALLATION

ALL DIMENSIONS SUBJECT TO 1/4" TOLERANCES

SCALE: 1/2" = 1'-0"

DATE: 3/27/02

JOB : STANDARD INSTALL

DW #: SI-1, SI-2

NOTE:

Sump pump or gravity drain is required for removing water from vault

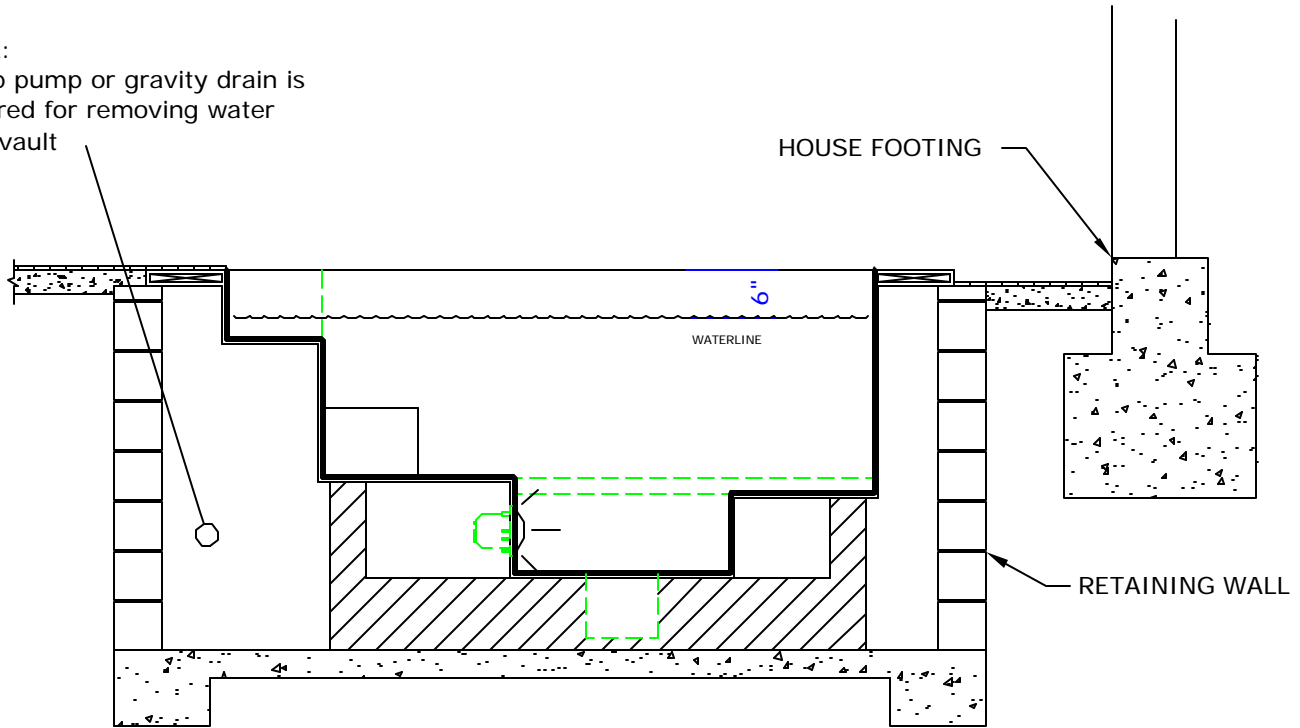

STANDARD VAULT INSTALLATION

SI-1

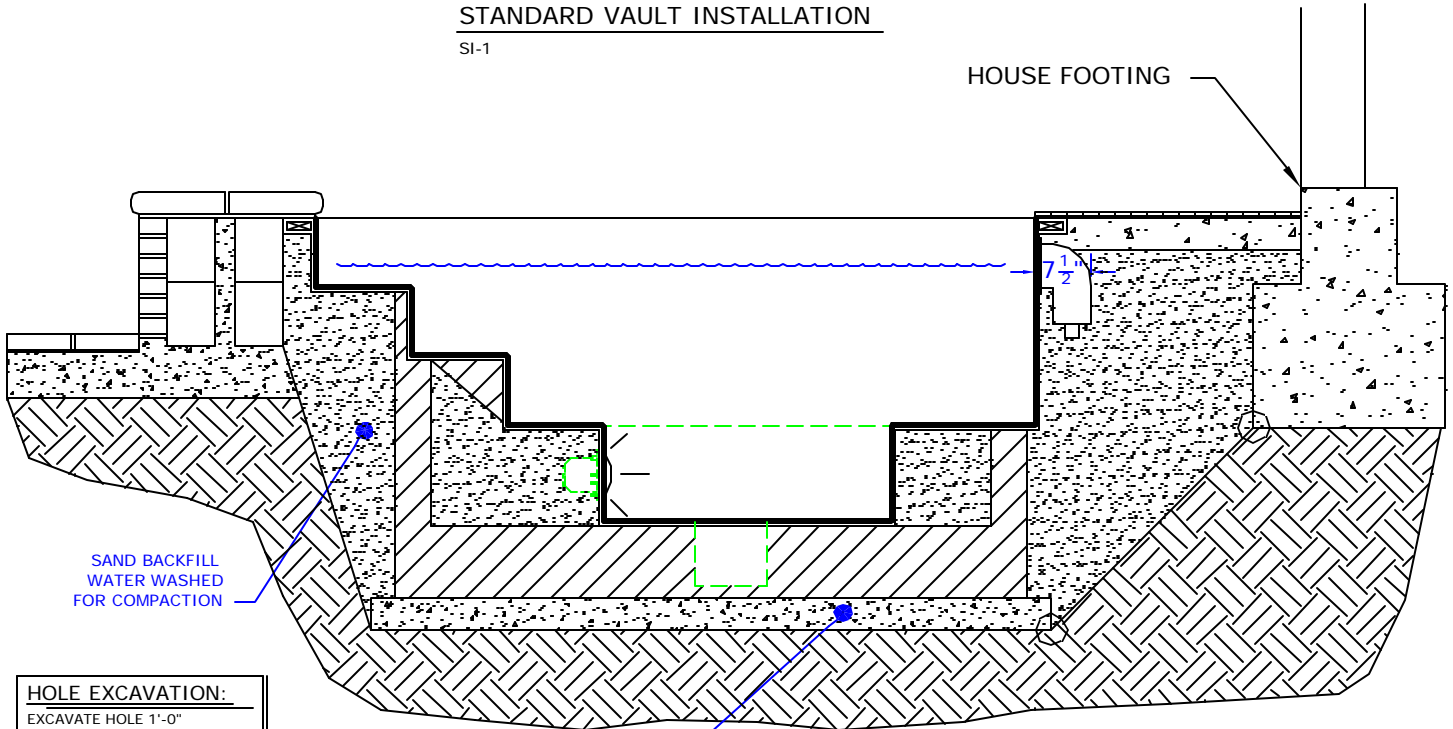

HOLE EXCAVATION:
EXCAVATE HOLE 1'-0"
LARGER THAN THE OUTSIDE
DIAMETER (OD) OF SPA

4" CONCRETE SLAB
REINFORCED WITH
#10 MESH

STANDARD INGROUND INSTALLATION

SI-2

NOTE:

Footing can not surcharge spa.
Slope from bottom of slab to
nearest corner of house footing
must not exceed 1" = 1".

POOL BONDING REQUIREMENTS:

1. THE FOLLOWING PARTS SHALL BE BONDED TOGETHER AND CONNECTED TO THE COMMON BONDING GRID.

- A. ALL THE METALLIC PARTS OF THE POOL STRUCTURE INCLUDING COPING STONES, DECK, PERMANENT PLAY STRUCTURES, PERMANENT EXERCISE STRUCTURES.
- B. ALL METAL FITTINGS WITHIN OR ATTACHED TO THE POOL STRUCTURE
- C. METAL PARTS ASSOCIATED WITH THE POOL WATER CIRCULATING SYSTEM, INCLUDING PUMPS, FILTERS, AND HEATERS.
- D. METAL PARTS ASSOCIATED WITH POOL COVERS
- E. METAL SHEATHED CABLES AND RACEWAYS, METAL PIPING AND ALL FIXED METAL PARTS WITHIN 5 FEET HORIZONTALLY OF INSIDE WALLS OF POOL AND WITHIN 12 FEET ABOVE MAXIMUM WATER LEVEL OF POOL.
- F. METAL PARTS ASSOCIATED WITH OBSERVATION STANDS, TOWERS, PLATFORMS, AND DIVING STRUCTURES.

2. BONDING CONDUCTORS SHALL BE MINIMUM #8 SOLID COPPER, INSULATED E.C. SHALL COORDINATE APPROVED CONNECTOR TYPE AND METHOD WITH LOCAL ELECTRICAL AND/OR POOL INSPECTOR.

3. SPECIFIC MANUFACTURER'S INSTRUCTIONS REGARDING BONDING OR GROUNDING OF POOL EQUIPMENT, WHETHER INDICATED HEREIN OR NOT, SHALL BE STRICTLY FOLLOWED.

4. THE COMMON BONDING GRID SHALL NOT BE CONNECTED TO ANY ELECTRICAL DISTRIBUTION EQUIPMENT.

5. ANY PARTS IN ADDITION TO THOSE DESCRIBED HEREIN THAT ARE INDICATED BY POOL CONTRACTOR OR LOCAL INSPECTION AUTHORITY SHALL BE BONDED TO THE COMMON BONDING GRID WITH NO ADDITIONAL COSTS INCURRED BY THE OWNER.

6. THE ELECTRICAL CONTRACTOR SHALL COORDINATE BONDING WITH GENERAL CONTRACTOR.

LIGHT DETAIL

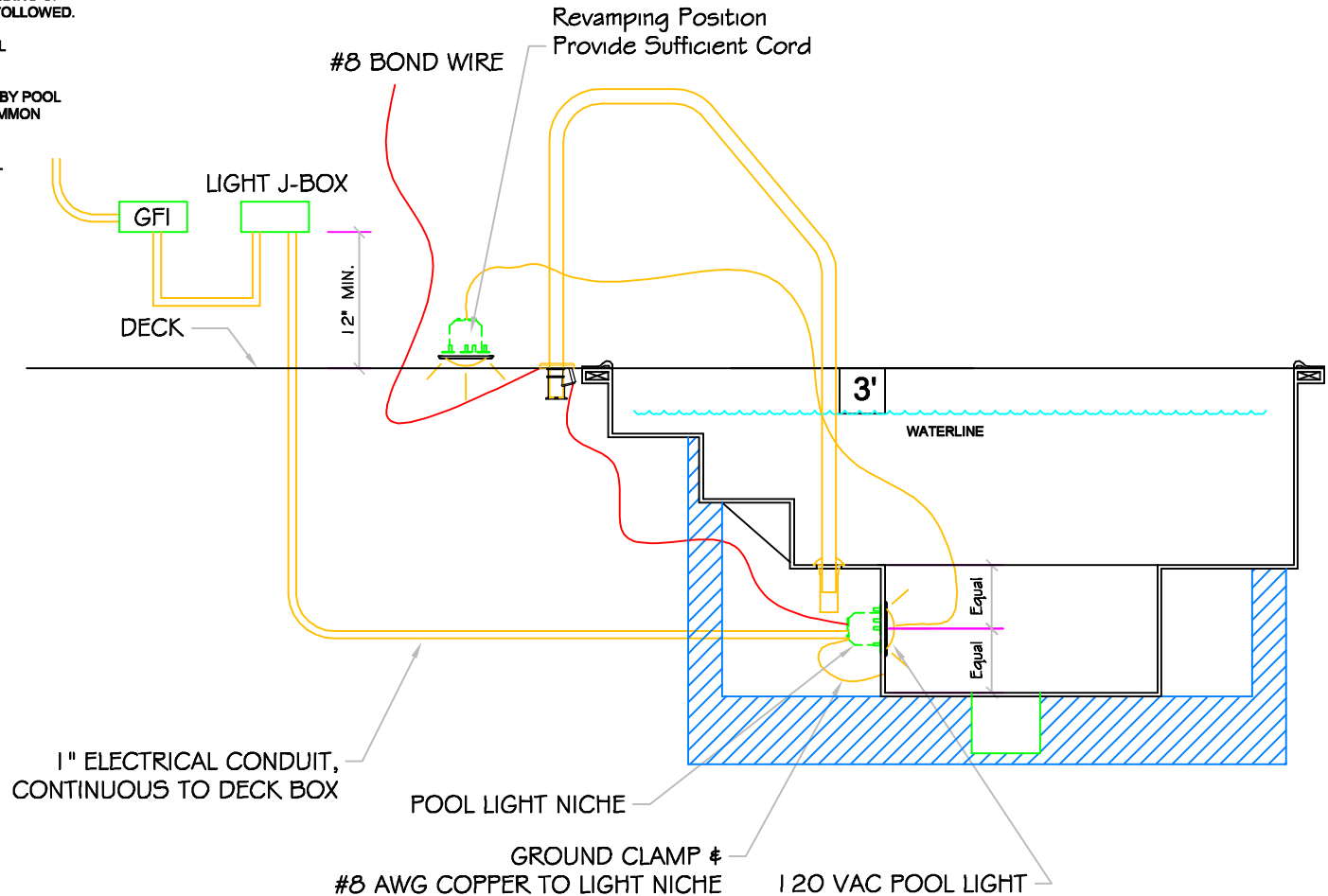

ALL DIMENSIONS SUBJECT TO 1/4" TOLERANCES

These drawings, concepts, and details contained herein are the original proprietary designs of NESPA ENTERPRISES, developed over many years of experience in the pool and spa industry and as such are protected by the copyright laws of the United States Government. Reproduction of any of the above without written permission to do so by NESPA ENTERPRISES, is illegal.

NESPA ENTERPRISES INC.

2800 Richter Ave. Ste. C Oroville, CA 95966

Office: (530) 534-9910

Fax: (530) 534-9915

E-Mail: sales@tiledspas.com Web Site: www.tiledspas.com



SIZE A	DWG TYPE LIGHT DETAIL	DWG NO. SPA DETAILS	REV 0
SCALE 1/2" = 1'	DATE 2/5/2007	SHEET PAGE 1 OF 1	



NESPA ENTERPRISES, Inc. LIMITED WARRANTY

This LIMITED WARRANTY covering NESPA products is extended to the ORIGINAL PURCHASER-USER BY NESPA ENTERPRISES Inc. (NESPA), 2800 Richter Ave. Unit E California 95965.

NESPA products are thoroughly inspected and tested prior to factory shipment. NESPA warrants to the ORIGINAL PURCHASER-USER that NESPA Spas and Swim Spas will be free of defect in workmanship, accessories and parts, provided said accessories and parts were manufactured by NESPA. NESPA, under this LIMITED WARRANTY, warrants only that its Spas and Swim Spas shall be structurally sound, shall retain their shape, and shall retain water for the warranty period. NESPA warrants the adhesion of tile to fiberglass for a period of five (5) years and structural soundness for ten (10) years. NESPA warrants epoxy grout adhesion for a period of three years. If any such defects appear and are reported within the warranty period, NESPA shall repair or replace such defective parts without charge if an inspection proves the claim.

The provisions of the LIMITED WARRANTY shall not apply to tile cracked, split, chipped or damaged after the product has left the factory, nor damage to tile caused by freezing nor to damage, defect, malfunction or failure to conform with the above warranty provisions where the damage, defect, malfunction or failure to conform was caused during shipment or by distributor or by unreasonable use by ORIGINAL PURCHASER-USER including improper water balance and improper sand pack or support.

This LIMITED WARRANTY shall not apply to any plumbing, equipment, or installation of spas and Swim Spas and shall not apply to any alterations made to or upon NESPA products except alterations made by NESPA employees or NESPA authorized representatives.

This LIMITED WARRANTY is expressly in lieu of all other warranties expressed or implied including the warranties of merchantability and fitness for use and all other obligations or liabilities on NESPA'S part, and NESPA neither assumes nor authorizes any other person to assume for NESPA any other liability in connection with the sale of this NESPA product. This LIMITED WARRANTY shall not apply to this NESPA product or any part thereof, which has been subject to accident, negligence, alteration, abuse or misuse. NESPA makes no warranty whatsoever with respect to accessories or parts not manufactured by NESPA.

The term "ORIGINAL PURCHASER-USER" as used in this LIMITED WARRANTY shall be deemed to mean that person for whom the NESPA product is originally installed.

The LIMITED WARRANTY provided herein and the obligations and liabilities of NESPA hereunder are exclusive and are in lieu of, and buyer and original PURCHASE-USER hereby waive all other remedies, warranties, guarantees or liabilities, expressed or implied, arising by law or otherwise (including without limitation and obligations of NESPA with respect to fitness, merchantability, and consequential damages) or whether or not occasioned by NESPA'S negligence.

This LIMITED WARRANTY shall not be extended, altered or varied except by a written instrument signed by NESPA and original PURCHASER-USER.